

GROVE®

GMK4100L-2

Product Guide

ASME B30.5 Imperial 85%



115 USt
(100 t)



197 ft
(60 m)



292 ft
(89 m)

GROVE
CONNECT™

GROVE GMK4100L-2

FEATURES

With high capacities and industry-leading compact dimensions, the GMK4100L-2 allows you to secure more jobs than ever before.

- Access narrow jobsites and utilize a more compact radius to gain a better position for lift performance. The GMK4100L-2's compact size and five outrigger positions provides excellent job site flexibility unmatched in the market.
- Human Machine Interface (HMI) allows for control of the MEGATRAK™ suspension system from both sides of the carrier allowing for adjustment of ground clearance independent of the outriggers. The GMK4100L-2 can also be equipped with an outrigger pad load indicator with visibility on both sides of the carrier or from the operators cab.



MAXbase variable outrigger positioning

MAXbase provides increased flexibility on the jobsite by allowing asymmetrical outrigger spans. This makes it easier to work in congested jobsites with obstructions and allows for increased capacities.

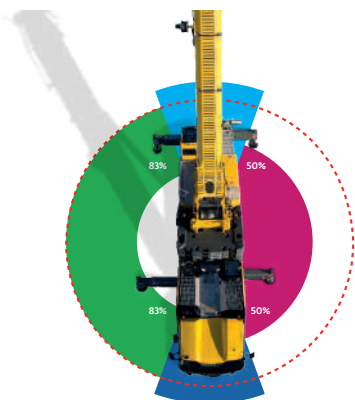

Fuel-Efficient Single Engine Concept

Equipped with a Mercedes-Benz Tier 4 final engine the GMK4100L-2 utilized a single-engine concept to keep fuel consumption to a minimum. Using the ECO mode, the GMK4100L-2 is the most fuel-efficient crane in its class.

Industry-leading compact dimensions

The minimum width of the GMK4100L-2 is 8.4 ft (2,55 m) and the overall length is 43.3 ft (13,18 m).

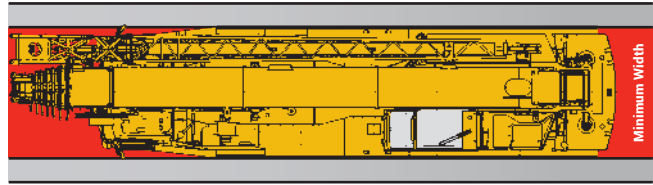

Latest Gen Cab

The full vision cab was designed with operator comfort, visibility, and productivity in mind. Standard features include 20 degree cab tilt, dual CCS displays, ergonomically friendly jog dial for operating system control, radio with Bluetooth, and adjustable comfort seat.

GROVE[®]

CONNECT[™]

GROVE CONNECT transforms the user experience of crane owners and makes everyday work easier.

Get access to secure, accurate data with an easy and intuitive remote 'real time' view on your crane's operation.



Scan to learn more or visit manitowoc.com/support.



KEEP YOUR CRANE CONNECTED

Grove MEGATRAK[®]

MEGATRAK[™] independent suspension, all-wheel steering system and steer by wire technology provides increased ground clearance, adjustable suspension and reduces tire wear to provide maximum maneuverability in all-terrains.



The world's most advanced crane service and support network

WORLDWIDE SUPPORT NETWORK

Manitowoc's customer service extends beyond any borders. Our locations span the globe, covering five continents. No matter where the job takes you, you have a business partner nearby.



PARTS

Locating the correct part quickly is vital to managing your operations. With Manitowoc Customer Support, the parts you need are just a phone call or click away.

LIFT SOLUTIONS

The Manitowoc Crane Lift Solutions Team is dedicated to helping customers with unique and customized applications for their Manitowoc cranes, regardless of product line.

TRAINING

Manitowoc Training Centers offer courses for operators and technicians across the globe to provide in-depth instruction on crane operation, maintenance, and troubleshooting procedures.

EnCORE

Manitowoc's EnCORE program maximizes your investment by rebuilding or repairing your crane to extend its life significantly. EnCORE also includes remanufactured parts.



MANITOWOC FINANCE

Manitowoc Finance gets you in the field with the right equipment by giving you access to flexible, affordable financing. With Manitowoc Finance, equipment can be acquired with virtually no cash outlay, and unlike traditional lending, our financial products don't affect bank lines of credit. Your capital resources remain intact for times when you need ready access to cash.

Competitive rates with flexible financing options and payment schedules put you in control.

Did you know? Manitowoc Finance can finance used Manitowoc cranes. You can also trade-in your used fleet for upgrade and get financed by Manitowoc Finance.





CONTENTS

8

Dimensions

11

Counterweight

14

Data

15

Weights

17

Working Range / Load Charts - Main Boom

34

Working Range / Load Charts - Main Boom and Bi-fold Swingaway

38

Specifications

DIMENSIONS

Bi-Fold Swingaway Jib Configurations

	A	B	C	D
	26.2 ft (8,0 m)	5.6 ft (1,7 m)	26.2 ft (8,0 m)	20.1 ft (6,3 m)
31.8 ft (9,7 m)	--	x	x	--
52.5 ft (16,0 m)	--	x	x	x
57.1 ft (17,4 m)	x	x	x	--
78.7 ft (24,0 m)	x	x	x	x

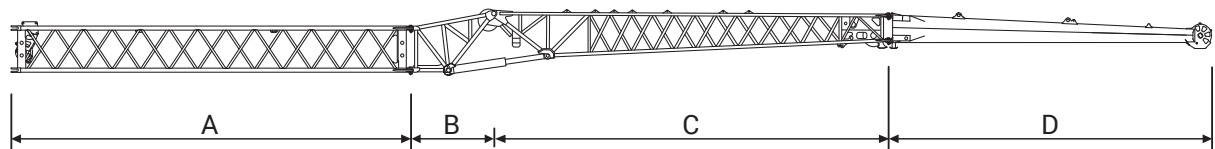
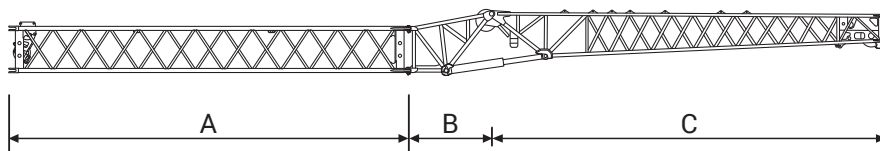
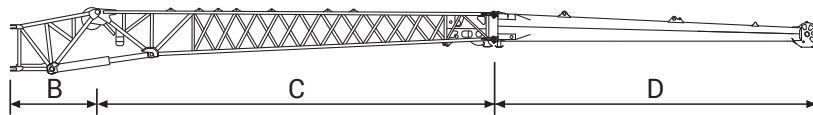
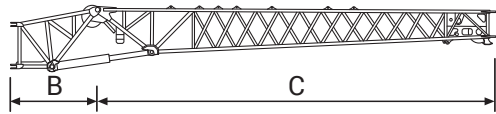

DIMENSIONS

Hose Reel

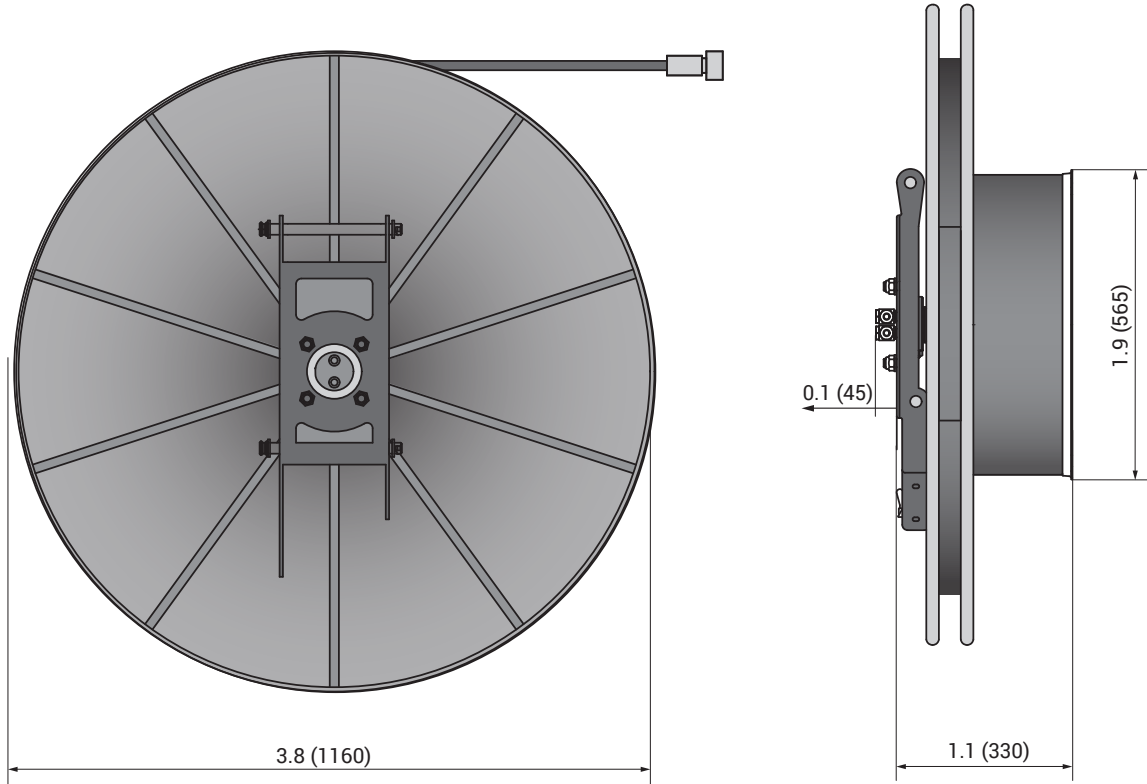

Dimensions shown are in ft (mm)

lb	388
----	-----

COUNTERWEIGHT

Standard Counterweight



	1 1,800 lb (0,8 t)	2 2,650 lb (1,2 t)	3 2,650 lb (1,2 t)	4 5,300 lb (2,4 t)	5 8,000 lb (3,6 t)	6 10,600 lb (4,8 t)	7 5,300 lb (2,4 t)
9,700 lb (4,4 t)	x				x		
12,300 lb (5,6 t)	x		x		x		
12,300 lb (5,6 t)	x	x			x		
14,900 lb (6,8 t)	x			x	x		
14,900 lb (6,8 t)	x	x	x		x		
17,600 lb (8,0 t)	x	x		x	x		
17,600 lb (8,0 t)	x		x	x	x		
20,200 lb (9,2 t)	x	x	x	x	x		
22,900 lb (10,4 t)	x	x		2x	x		
25,500 lb (11,6 t)	x	x	x	2x	x		
28,200 lb (12,8 t)	x	x		3x	x		
30,800 lb (14,0 t)	x	x	x	3x	x		
33,500 lb (15,2 t)	x	x		4x	x		
36,100 lb (16,4 t)	x	x	x	4x	x		
38,800 lb (17,6 t)	x	x		3x	x	x	
41,450 lb (18,8 t)	x	x	x	3x	x	x	
44,000 lb (20,0 t)	x	x		4x	x	x	
46,700 lb (21,2 t)	x	x	x	4x	x	x	
54,600 lb (24,8 t)	x	x		x	x	x	2x
57,300 lb (26,0 t)	x	x	x	4x	x	x	2x

COUNTERWEIGHT

Heavy Roadable Counterweight



	1 1,800 lb (0,8 t)	2 2,650 lb (1,2 t)	3 2,650 lb (1,2 t)	4 5,300 lb (2,4 t)	5 8,000 lb (3,6 t)	8 18,500 lb (8,4 t)	7 5,300 lb (2,4 t)
22,900 lb (10,4 t)	x		x	2 x	x		
25,500 lb (11,6 t)	x		2 x	2 x	x		
25,500 lb (11,6 t)	x	x	x	2 x	x		
28,200 lb (12,8 t)	x	x	2 x	2 x	x		
44,000 lb (20,0 t)	x	x	x	2 x	x	x	
46,700 lb (21,2 t)	x	x	2 x	2 x	x	x	
54,600 lb (24,8 t)	x	x	x	2 x	x	x	2 x
57,300 lb (26,0 t)	x	x	2 x	2 x	x	x	2 x

COUNTERWEIGHT

Fully Removable Counterweight

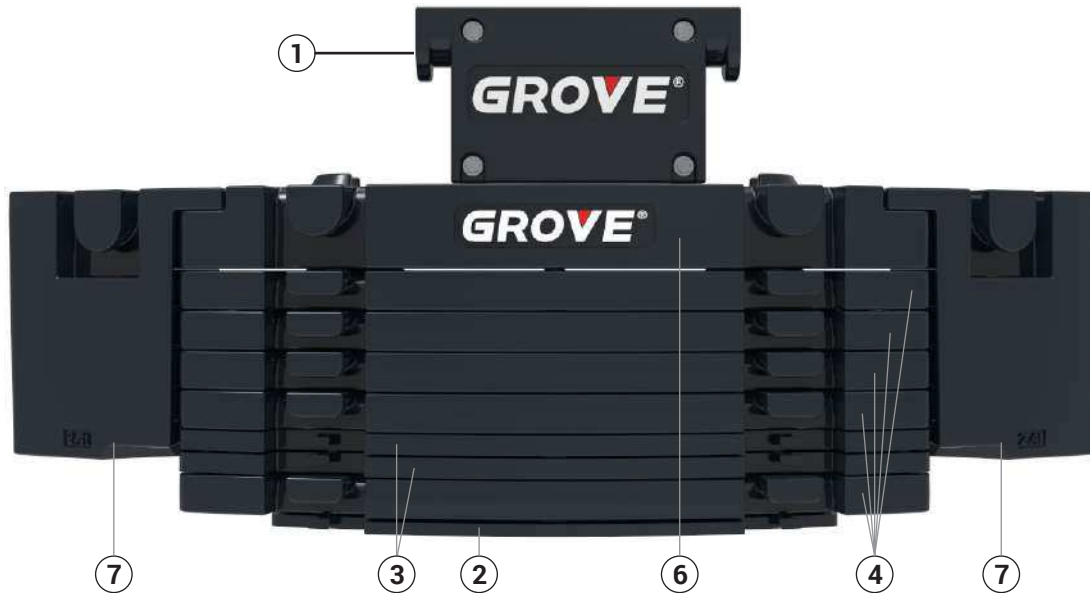

	1 1,800 lb (0,8 t)	2 2,650 lb (1,2 t)	3 2,650 lb (1,2 t)	4 5,300 lb (2,4 t)	6 10,600 lb (4,8 t)	7 5,300 lb (2,4 t)
1,700 lb (0,8 t)	x					
4,400 lb (2,0 t)	x	x				
7,100 lb (3,2 t)	x	x	x			
9,700 lb (4,4 t)	x	x		x		
12,300 lb (5,6 t)	x	x	x	x		
14,900 lb (6,8 t)	x	x		2 x		
17,600 lb (8,0 t)	x	x	x	2 x		
20,200 lb (9,2 t)	x	x		3 x		
22,900 lb (10,4 t)	x	x	x	3 x		
25,500 lb (11,6 t)	x	x		4 x		
28,200 lb (12,8)	x	x	x	4 x		
30,800 lb (14,0 t))	x	x		5 x		
33,500 lb (15,2 t)	x	x	x	5 x		
36,100 lb (16,4 t)	x	x		4 x	x	
38,800 lb (17,6 t)	x	x	x	4 x	x	
41,450 lb (18,8 t)	x	x		5 x	x	
44,000 lb (20,0 t)	x	x	x	5 x	x	
46,700 lb (21,2 t)	x	x	2 x	5 x	x	
54,600 lb (24,8 t)	x	x	x	5 x	x	2 x
57,300 lb (26,0 t)	x	x	2 x	5 x	x	2 x

DATA



Lifting Capacity	Sheaves	Weight	Parts of line	Possible load with crane*
110 USt (100 t)	7	2204 lb (1000 kg)	2 - 15	99 USt (90 t)*
88 USt (80 t)	5	1653 lb (750 kg)	2 - 11	85 USt (77 t)
55 USt (50 t)	3	1984 lb (900 kg)	1 - 7	54 USt (49 t)
29 USt (26 t)	1	882 lb (400 kg)	1 - 3	23 USt (21 t)
10 USt (9 t)	Overhaul weight	660 lb (300 kg)	1	8 USt (7 t)

* 0° over rear with additional equipment



	1	2	3	4	5	6	7	8	9	10	11	12	13	14	15	16	R1	R2	
mp/h	3.9	4.7	5.8	7.0	8.7	10.5	12.4	15.5	17.4	21.1	25.5	31.1	38.5	46.6	52.8	52.8	3.9	4.8	
mp/h	1.8	2.2	2.6	3.1	3.9	4.7	5.6	6.8	8.0	9.3	11.8	14.3	17.4	21.1	25.5	30.4	1.8	2.2	70%
	14.00 R25																		



	Infinitely Variable	Rope	Max. Single Line Pull
	0-394 f/min (0 - 120 m/min) Single Line	19 mm / 836 ft (19 mm / 255 m)	15,872 lb (70,6 kN)
	0-394 f/min (0 - 120 m/min) Single Line	19 mm / 836 ft (19 mm / 255 m)	15,872 lb (70,6 kN)
	0 - 1,7 min ⁻¹		
	-1,5° to + 82° Approx. 50 s		
	37.1 to 196.9 ft (11,3 to 60,0 m) Approx. 500 s		

WEIGHTS

Boom Over Front

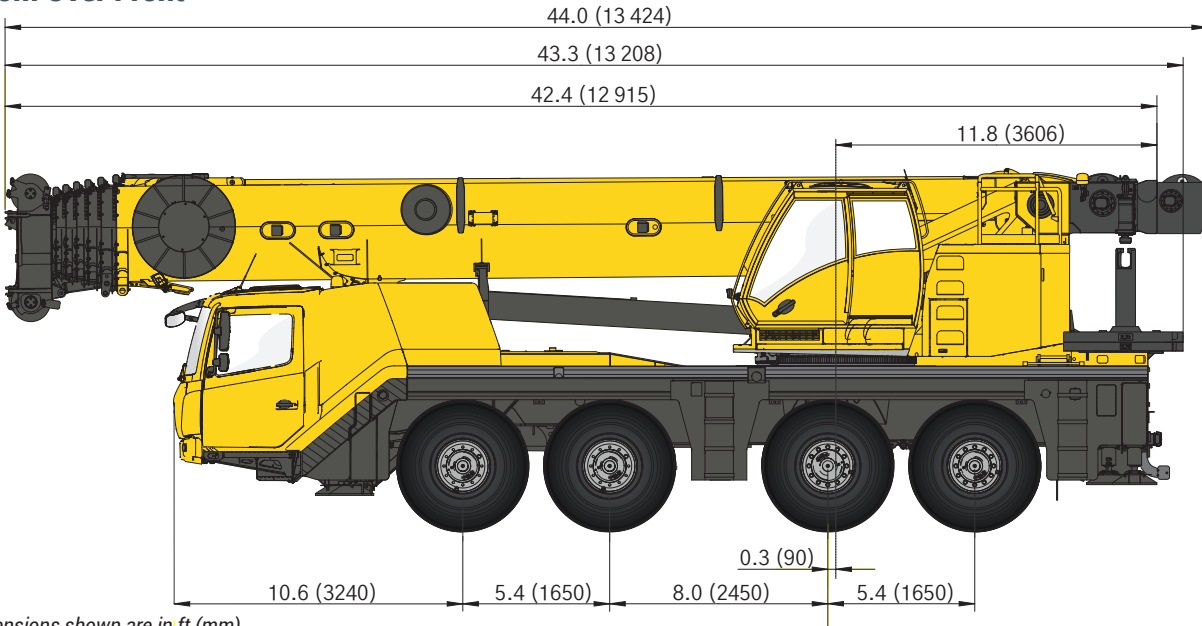

Dimensions shown are in ft (mm)

Basic Weights	Axles 1 & 2	Axles 3 & 4	Total
16.00 R25, 8x6x8 drive/steer, nylatron outrigger pads, single sheave hook block, hose reel, 4.8t (10,600 lb) counterweight fixed on superstructure	52,600 lb (23 860 kg)	52,660 lb (23 890 kg)	105,250 lb (47 740 kg)

Trailing Boom

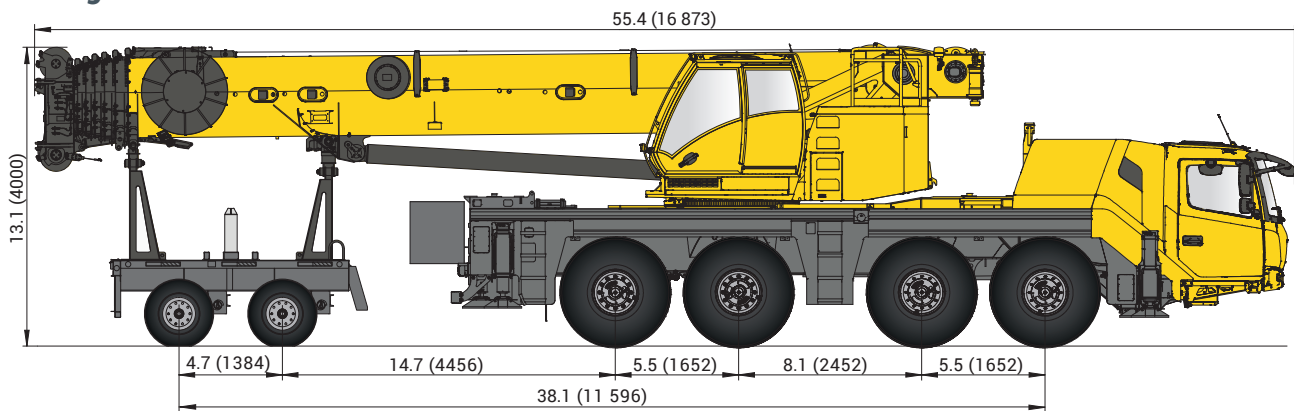

Dimensions shown are in ft (mm)

*Boom dolly mode requires fully removable counterweight option.

Basic Weights	Axles 1 & 2	Axles 3 & 4	Dolly	Total
20.5 R25 on steel, 8x6x8 drive/steer, 31.8 ft to 52.5 ft (9.7 m to 16 m) & hose reel, nylatron outrigger pads, aux hoist, single sheave block hanging over boom nose, 2 axle boom dolly (5100 lb/ 2300 kg), 2650 lb (1.2t) counterweight tray installed on dolly, rear rigging box full of timber, T1 telescoped 14 ft.	39,900 lb (9050 kg)	27,800 lb (6310 kg)	39,900 lb (9050 kg)	107,610 lb (48 810 kg)

* To acquire a custom roading scenario for your region please see your local dealer or Manitowoc representative.

LOAD CHART

Main Boom

 37 ft - 197 ft
(11,3 - 60, 0 m)

 23.6 ft
(7,2 m)

 360°

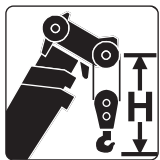
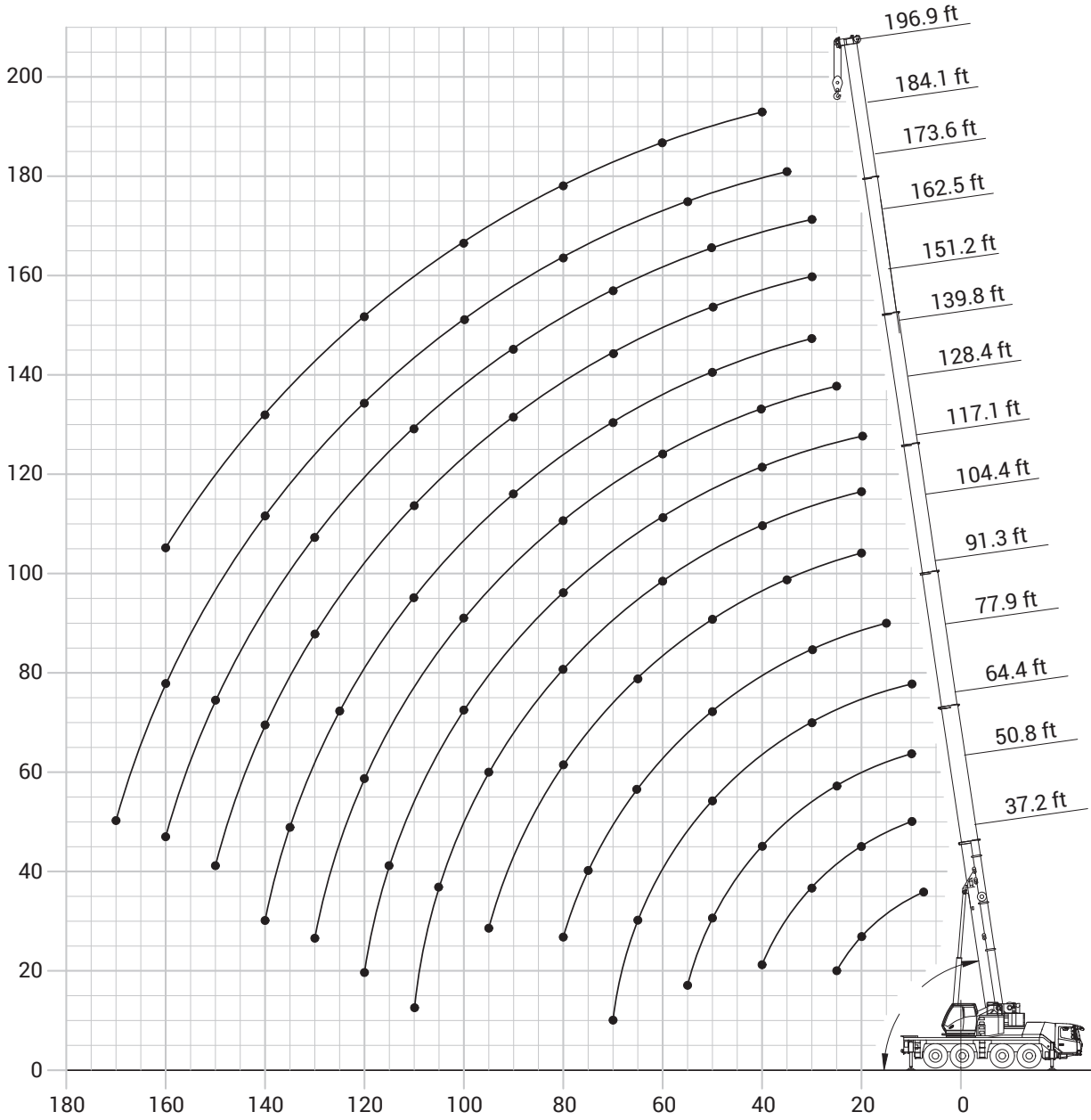

Hook block (USt)	H (ft)
110 D	10.2
88 E/D	9.5
55 E/D	9.2
29 E/D	9.2
10 H/B	7.7

LOAD CHART

Main Boom



37 ft – 197 ft
(11,3 – 60, 0 m)



57,300 lb
(26 t)



23.6 ft
(7,2 m)



360°



Pounds x 1000

Feet	37.2	50.5	64.4	77.9	91.3	104.4	117.1	128.4	139.8	150.5	156-162	173.5	184.1	190.4	196.9
10	167.0	167.0	166.0												
15	130.0	130.0	130.0	130.0											
20	104.0	105.0	105.0	94.0	100.0	82.0	69.0								
25	87.0	88.0	87.0	87.0	88.0	76.0	67.0	54.0							
30		73.0	72.0	72.0	73.0	69.0	63.0	53.0	44.0	38.4					
35		62.0	59.0	62.0	61.0	61.0	58.0	48.0	43.0	38.2	30.4				
40		52.0	53.0	53.0	50.0	50.0	50.0	43.2	40.0	36.8	30.4	25.6	21.8	19.0	17.8
45			45.0	45.0	45.0	42.6	42.8	39.4	36.6	34.6	30.0	25.6	21.8	19.0	17.8
50			38.0	37.6	39.0	38.2	37.0	35.0	33.4	32.0	28.2	25.6	21.8	19.0	17.8
55			33.8	34.2	33.6	34.6	32.2	30.4	29.6	29.6	26.4	24.6	21.8	18.8	17.6
60				29.6	29.0	30.4	28.4	26.8	26.0	26.2	24.8	23.2	21.8	18.8	17.4
65				25.8	25.2	26.8	25.0	23.6	22.8	23.2	22.6	21.8	20.6	18.4	17.2
70				14.2	22.0	23.6	23.6	20.8	20.2	20.6	20.0	20.2	19.6	18.0	16.6
75					19.2	20.8	21.8	18.6	18.0	18.4	17.8	18.0	18.4	17.2	15.4
80					17.0	19.4	19.4	16.4	16.0	17.2	16.0	16.8	16.6	16.2	14.4
85						18.2	17.4	14.4	14.2	16.2	14.4	15.6	14.8	15.0	13.6
90						16.4	15.8	12.6	12.6	15.2	13.4	14.4	13.4	13.6	12.6
95						13.2	14.2	11.8	11.4	13.8	12.6	13.2	12.2	12.2	11.8
100							12.8	11.2	10.6	12.6	11.8	12.0	11.0	11.0	10.8
105							11.6	10.6	10.0	11.2	11.0	10.8	10.0	10.0	9.8
110								10.2	9.4	10.2	10.4	9.8	9.4	9.0	8.8
115								9.8	9.0	9.2	9.4	8.8	8.8	8.2	8.0
120								4.6	8.4	8.2	8.6	8.0	8.0	7.4	7.2
125									8.0	7.4	7.8	7.0	7.2	6.6	6.4
130									6.4	6.6	7.4	6.6	6.4	5.8	5.6
135									5.0	6.0	7.0	6.2	5.8	5.0	5.0
140										5.4	6.4	5.6	5.0	4.4	4.2
145											5.8	5.0	4.4	3.8	3.6
150											4.4	4.6	4.0	3.2	3.0
155												4.0	3.4	2.8	2.6
160												3.6	3.0	2.2	2.0
165													2.4		
170													2.0		

*Boom length noted represents range of similar lengths.

THIS CHART IS ONLY A GUIDE AND SHOULD NOT BE USED TO OPERATE THE CRANE.

The individual crane's load chart, operating instructions and other instructional plates must be read and understood prior to operating the crane

LOAD CHART

Main Boom

 37 ft - 197 ft
(11,3 - 60, 0 m)

 54,600 lb
(24,8 t)

 23.6 ft
(7,2 m)

 360°



Pounds x 1000

Feet	37.2	50.5	64.4	77.9	91.3	104.4	117.1	128.4	139.8	150.5	156-162	173.5	184.1	190.4	196.9
10	167.0	167.0	166.0												
15	130.0	130.0	130.0	129.0											
20	104.0	105.0	105.0	104.0	100.0	82.0	69.0								
25	87.0	88.0	87.0	87.0	88.0	76.0	67.0	54.0							
30		73.0	72.0	71.0	72.0	69.0	63.0	53.0	44.0	38.4					
35		61.0	60.0	61.0	59.0	59.0	58.0	48.0	43.0	38.2	30.4				
40		52.0	52.0	52.0	50.0	49.0	49.0	43.2	40.0	36.8	30.4	25.6	21.8	19.0	17.8
45			44.0	43.6	43.8	41.6	41.4	39.2	36.6	34.6	30.0	25.6	21.8	19.0	17.8
50			36.8	37.4	37.6	38.2	35.6	33.8	32.8	32.0	28.2	25.6	21.8	19.0	17.8
55			32.8	33.0	32.4	33.4	31.0	29.4	28.6	28.8	26.4	24.6	21.8	18.8	17.6
60				28.6	27.8	29.4	27.2	25.6	25.0	25.2	24.6	23.2	21.8	18.8	17.4
65				24.8	24.2	25.8	25.0	22.6	22.0	22.4	21.6	21.8	20.6	18.4	17.2
70				14.2	21.0	22.6	23.6	20.0	19.4	19.8	19.2	19.4	19.6	18.0	16.6
75					18.4	20.2	21.0	17.8	17.2	18.2	17.0	18.0	17.6	17.2	15.4
80					16.2	19.4	18.8	15.6	15.2	17.2	15.4	16.8	15.8	15.8	14.4
85						17.6	16.8	13.8	13.6	16.2	14.4	15.2	14.2	14.2	13.6
90						15.8	15.0	12.6	12.0	14.6	13.4	13.8	12.8	12.8	12.6
95						12.6	13.6	11.8	11.4	13.2	12.6	12.6	11.6	11.6	11.4
100							12.2	11.2	10.6	12.0	11.8	11.4	10.6	10.4	10.2
105							11.0	10.6	10.0	10.6	11.0	10.4	10.0	9.4	9.2
110								10.2	9.4	9.6	10.0	9.4	9.4	8.6	8.2
115									9.0	8.6	9.0	8.4	8.4	7.6	7.4
120									8.4	7.8	8.2	7.6	7.6	7.0	6.6
125									8.0	7.0	7.8	7.0	6.8	6.0	6.0
130									3.4	6.2	7.2	6.6	6.0	5.4	5.2
135										5.6	6.6	6.0	5.2	4.6	4.4
140										5.0	6.0	5.2	4.6	4.0	3.8
145											5.4	4.6	4.0	3.4	3.2
150												4.2	3.6	2.8	2.8
155												3.6	3.0	2.4	2.2
160												3.2	2.6	2.0	
165													2.2		

*Boom length noted represents range of similar lengths.

THIS CHART IS ONLY A GUIDE AND SHOULD NOT BE USED TO OPERATE THE CRANE.

The individual crane's load chart, operating instructions and other instructional plates must be read and understood prior to operating the crane

LOAD CHART

Main Boom



37 ft – 197 ft
(11,3 – 60, 0 m)



46,700 lb
(21,2 t)



23.6 ft
(7,2 m)



360°



Pounds x 1000

Feet	37.2	50.5	64.4	77.9	91.3	104.4	117.1	128.4	139.8	150.5	156-162	173.5	184.1	190.4	196.9
10	166.0	167.0	165.0												
15	129.0	130.0	130.0	129.0											
20	104.0	105.0	104.0	104.0	100.0	82.0	69.0								
25	85.0	87.0	86.0	85.0	87.0	76.0	67.0	54.0							
30		71.0	70.0	70.0	67.0	66.0	63.0	53.0	44.0	38.4					
35		59.0	59.0	57.0	56.0	53.0	53.0	48.0	43.0	38.2	30.4				
40		48.0	48.0	47.0	47.0	46.0	43.8	41.6	40.0	36.8	30.4	25.6	21.8	19.0	17.8
45			39.8	41.0	39.4	39.8	37.2	35.2	34.0	34.2	30.0	25.6	21.8	19.0	17.8
50			34.6	34.8	33.8	34.4	32.0	30.2	29.2	29.4	28.2	25.6	21.8	19.0	17.8
55			29.4	29.6	29.0	29.8	28.4	26.0	25.2	25.6	24.8	24.6	21.8	18.8	17.6
60				26.2	24.8	26.2	26.6	22.6	22.0	22.4	21.6	21.8	21.8	18.8	17.4
65				23.8	21.4	23.0	23.6	19.8	19.2	20.6	19.6	20.4	19.4	18.4	17.2
70				14.2	19.0	21.4	21.0	17.4	16.8	19.4	18.2	18.4	17.2	17.2	16.6
75					18.0	19.4	18.6	15.2	15.0	17.4	16.6	16.4	15.4	15.4	15.0
80					14.0	17.2	16.6	14.2	13.8	15.6	15.4	14.8	13.8	13.8	13.4
85						15.4	14.6	13.4	13.0	14.0	14.2	13.2	13.0	12.2	12.0
90						13.8	13.0	12.6	12.0	12.8	12.8	11.8	11.8	11.0	10.6
95						10.8	11.6	11.8	11.4	11.4	11.6	10.6	10.6	9.8	9.6
100							10.4	11.2	10.6	10.2	10.6	9.6	9.6	8.8	8.4
105							9.4	10.6	10.0	9.0	9.6	8.6	8.6	7.8	7.6
110								9.8	9.4	8.0	9.2	7.8	7.8	7.0	6.6
115								8.8	8.4	7.2	8.2	6.8	7.0	6.2	6.0
120								4.6	7.6	6.4	7.4	6.0	6.2	5.4	5.2
125								3.8	6.8	5.6	6.6	5.2	5.4	4.8	4.6
130									2.2	4.8	6.0	4.6	4.6	4.0	3.8
135										4.2	5.4	3.8	4.0	3.4	3.2
140										3.8	4.8	3.4	3.4	2.8	2.6
145											4.2	2.8	3.0	2.2	2.0
150												2.2	2.4		
155													2.0		

*Boom length noted represents range of similar lengths.

THIS CHART IS ONLY A GUIDE AND SHOULD NOT BE USED TO OPERATE THE CRANE.

The individual crane's load chart, operating instructions and other instructional plates must be read and understood prior to operating the crane

LOAD CHART

Main Boom



37 ft - 197 ft
(11,3 - 60, 0 m)



44,000 lb
(20,0 t)



23.6 ft
(7,2 m)



360°



Pounds x 1000

Feet	37.2	50.5	64.4	77.9	91.3	104.4	117.1	128.4	139.8	150.5	156-162	173.5	184.1	190.4	196.9
10	166.0	166.0	165.0												
15	129.0	130.0	129.0	129.0											
20	104.0	105.0	104.0	104.0	100.0	82.0	69.0								
25	85.0	86.0	85.0	85.0	84.0	76.0	67.0	54.0							
30		70.0	69.0	69.0	64.0	63.0	63.0	53.0	44.0	38.4					
35		58.0	58.0	55.0	55.0	51.0	51.0	48.0	43.0	38.2	30.4				
40		47.0	47.0	45.0	45.0	45.0	42.4	40.0	38.6	36.8	30.4	25.6	21.8	19.0	17.8
45			39.8	40.0	38.0	38.4	35.8	33.8	32.8	32.8	30.0	25.6	21.8	19.0	17.8
50			33.2	33.4	32.4	33.0	30.6	28.8	28.0	28.2	27.4	25.6	21.8	19.0	17.8
55			28.2	28.4	27.8	28.8	28.4	25.0	24.2	24.4	23.6	23.8	21.8	18.8	17.6
60				26.2	23.6	25.2	25.6	21.6	21.0	22.0	21.2	21.8	21.0	18.8	17.4
65				22.8	20.4	22.0	22.8	18.8	18.2	20.6	19.6	19.8	18.6	18.4	17.2
70				14.2	19.0	19.2	20.2	16.6	16.2	18.6	18.2	17.6	16.4	16.4	16.0
75					18.0	16.8	17.8	15.2	15.0	16.6	16.6	15.6	15.0	14.6	14.2
80					13.2	14.8	15.8	14.2	13.8	15.0	15.0	14.0	13.8	13.0	12.6
85						13.0	14.0	13.4	13.0	13.4	13.6	12.6	12.4	11.6	11.2
90						11.6	12.4	12.6	12.0	12.0	12.2	11.2	11.2	10.4	10.0
95						10.2	11.0	11.8	11.4	10.8	11.0	10.0	10.0	9.2	9.0
100							9.8	11.2	10.6	9.6	10.2	9.0	9.0	8.2	8.0
105							8.8	10.2	9.8	8.4	9.6	8.0	8.0	7.2	7.0
110								9.2	8.8	7.6	8.6	7.2	7.2	6.4	6.2
115								8.4	8.0	6.6	7.8	6.4	6.4	5.6	5.4
120								3.2	7.2	5.8	7.0	5.6	5.6	5.0	4.8
125									6.4	5.2	6.2	4.8	5.0	4.2	4.0
130									3.0	4.4	5.6	4.0	4.2	3.6	3.4
135										3.8	4.8	3.4	3.6	3.0	2.8
140										3.4	4.4	3.0	3.0	2.4	2.2
145											3.8	2.4	2.6	1.8	
150											2.6	1.8	2.0		

*Boom length noted represents range of similar lengths.

THIS CHART IS ONLY A GUIDE AND SHOULD NOT BE USED TO OPERATE THE CRANE.

The individual crane's load chart, operating instructions and other instructional plates must be read and understood prior to operating the crane

LOAD CHART

Main Boom



37 ft – 197 ft
(11,3 – 60, 0 m)



41,400 lb
(18,8 t)



23.6 ft
(7,2 m)



360°



Pounds x 1000

Feet	37.2	50.5	64.4	77.9	91.3	104.4	117.1	128.4	139.8	150.5	156-162	173.5	184.1	190.4	196.9
10	166.0	166.0	165.0												
15	129.0	129.0	129.0	129.0											
20	104.0	105.0	104.0	103.0	100.0	82.0	69.0								
25	84.0	85.0	84.0	84.0	81.0	76.0	67.0	54.0							
30		69.0	68.0	67.0	64.0	61.0	60.0	53.0	44.0	38.4					
35		56.0	57.0	53.0	53.0	51.0	49.0	46.0	43.0	38.2	30.4				
40		43.8	45.0	45.0	43.4	43.6	40.8	38.4	37.2	36.8	30.4	25.6	21.8	19.0	17.8
45			38.4	38.6	36.6	37.0	34.4	32.4	31.4	31.6	30.0	25.6	21.8	19.0	17.8
50			32.0	32.2	31.2	31.8	30.4	27.6	26.8	27.0	26.2	25.6	21.8	19.0	17.8
55			27.0	28.4	26.6	27.6	28.0	23.8	23.0	23.6	22.8	23.0	21.8	18.8	17.6
60				25.2	22.6	24.2	24.6	20.6	20.0	22.0	21.2	21.2	20.0	18.8	17.4
65				21.8	20.2	21.0	21.8	18.0	17.6	20.0	19.6	18.8	17.6	17.6	17.2
70				14.2	19.0	18.2	19.4	16.4	16.2	17.8	17.8	16.8	16.2	15.6	15.2
75					18.0	16.0	17.0	15.2	15.0	15.8	16.0	14.8	14.8	13.8	13.6
80					12.6	14.0	15.0	14.2	13.8	14.2	14.4	13.2	13.2	12.4	12.0
85						12.4	13.2	13.4	13.0	12.6	12.8	11.8	11.8	11.0	10.6
90						11.6	11.8	12.6	12.0	11.4	11.6	10.6	10.6	9.8	9.4
95						9.6	10.4	11.8	11.4	10.2	10.8	9.4	9.4	8.6	8.4
100							9.2	10.8	10.4	9.0	10.2	8.4	8.4	7.6	7.4
105							8.2	9.6	9.2	8.0	9.0	7.6	7.4	6.8	6.4
110								8.8	8.2	7.0	8.2	6.6	6.6	6.0	5.6
115								7.8	7.4	6.2	7.2	5.8	6.0	5.2	4.8
120									6.6	5.4	6.4	5.0	5.2	4.4	4.2
125									6.0	4.6	5.8	4.4	4.4	3.8	3.6
130										4.0	5.0	3.6	3.8	3.2	3.0
135										3.4	4.4	3.0	3.2	2.6	2.4
140										3.0	4.0	2.6	2.6	2.0	
145											3.4	2.0	2.2		

*Boom length noted represents range of similar lengths.

THIS CHART IS ONLY A GUIDE AND SHOULD NOT BE USED TO OPERATE THE CRANE.

The individual crane's load chart, operating instructions and other instructional plates must be read and understood prior to operating the crane

LOAD CHART

Main Boom



37 ft - 197 ft
(11,3 - 60, 0 m)



38,800 lb
(17,6 t)



23.6 ft
(7,2 m)



360°



Pounds x 1000

Feet	37.2	50.5	64.4	77.9	91.3	104.4	117.1	128.4	139.8	150.5	156-162	173.5	184.1	190.4	196.9
10	166.0	166.0	165.0												
15	129.0	129.0	129.0	129.0											
20	104.0	105.0	104.0	103.0	100.0	82.0	69.0								
25	83.0	85.0	84.0	81.0	79.0	76.0	67.0	54.0							
30		68.0	67.0	65.0	63.0	59.0	58.0	53.0	44.0	38.4					
35		54.0	55.0	51.0	51.0	51.0	47.0	45.0	43.0	38.2	30.4				
40		43.2	43.6	44.0	41.8	42.0	39.2	37.0	35.6	35.6	30.4	25.6	21.8	19.0	17.8
45			36.8	37.0	35.0	35.6	33.0	31.0	30.0	30.2	29.2	25.6	21.8	19.0	17.8
50			30.6	30.8	29.8	30.6	30.4	26.4	25.6	25.8	25.0	25.0	21.8	19.0	17.8
55			25.8	28.0	25.4	26.4	26.8	22.6	22.0	23.6	22.8	23.0	21.8	18.8	17.6
60				24.0	21.6	23.0	23.6	19.6	19.0	21.6	21.2	20.4	19.2	18.8	17.4
65				20.8	20.2	20.0	20.8	17.6	17.6	19.0	19.2	18.0	17.4	16.8	16.4
70				14.2	19.0	17.4	18.4	16.4	16.2	17.0	17.0	15.8	15.8	14.8	14.4
75					17.2	15.2	16.2	15.2	15.0	15.0	15.2	14.2	14.0	13.2	12.8
80					11.8	13.2	14.2	14.2	13.8	13.4	13.6	12.6	12.4	11.6	11.2
85						12.4	12.6	13.4	13.0	12.0	12.4	11.2	11.0	10.2	10.0
90						11.6	11.2	12.6	12.0	10.8	11.6	10.0	9.8	9.0	8.8
95						9.0	9.8	11.2	10.8	9.6	10.6	8.8	8.8	8.0	7.8
100							8.6	10.2	9.8	8.4	9.6	7.8	7.8	7.0	6.8
105							8.2	9.2	8.6	7.4	8.6	7.0	7.0	6.2	5.8
110								8.2	7.8	6.4	7.6	6.2	6.2	5.4	5.2
115								7.4	7.0	5.6	6.8	5.4	5.4	4.6	4.4
120									6.2	4.8	6.0	4.6	4.6	4.0	3.8
125									5.6	4.2	5.2	3.8	4.0	3.4	3.2
130										3.6	4.6	3.2	3.4	2.8	2.6
135										3.0	4.0	2.6	2.8	2.2	2.0
140										2.6	3.6	2.0	2.2		
145											3.0				

*Boom length noted represents range of similar lengths.

THIS CHART IS ONLY A GUIDE AND SHOULD NOT BE USED TO OPERATE THE CRANE.

The individual crane's load chart, operating instructions and other instructional plates must be read and understood prior to operating the crane

LOAD CHART

Main Boom



37 ft – 197 ft
(11,3 – 60, 0 m)



36,100 lb
(16,4 t)



23.6 ft
(7,2 m)



360°



Pounds x 1000

Feet	37.2	50.5	64.4	77.9	91.3	104.4	117.1	128.4	139.8	150.5	156-162	173.5	184.1	190.4	196.9
10	166.0	166.0	165.0												
15	129.0	129.0	129.0	128.0											
20	103.0	105.0	104.0	103.0	100.0	82.0	69.0								
25	82.0	84.0	83.0	81.0	76.0	74.0	67.0	54.0							
30		67.0	66.0	62.0	61.0	57.0	56.0	53.0	44.0	38.4					
35		53.0	52.0	51.0	49.0	49.0	45.0	42.8	41.2	38.2	30.4				
40		41.4	43.2	42.6	40.2	40.4	37.6	35.4	34.2	34.2	30.4	25.6	21.8	19.0	17.8
45			35.4	35.6	33.6	34.2	32.8	29.8	28.8	29.0	26.0	25.6	21.8	19.0	17.8
50			29.4	30.8	28.4	29.2	29.6	25.2	24.4	25.2	24.4	24.2	21.8	19.0	17.8
55			24.6	26.8	24.2	25.2	25.8	21.6	20.8	23.6	22.8	22.2	20.8	18.8	17.6
60				23.0	20.6	22.0	22.6	19.0	18.0	20.6	20.6	19.4	18.6	18.2	17.4
65				20.0	17.4	19.2	19.8	17.6	15.4	18.2	18.2	17.0	16.8	16.0	15.6
70				13.4	15.0	16.6	17.6	16.4	13.4	16.0	16.2	15.0	15.0	14.0	13.6
75					12.8	14.4	15.4	15.2	11.6	14.2	14.4	13.4	13.2	12.4	12.0
80					11.0	13.0	13.4	14.2	10.0	12.6	13.2	11.8	11.8	10.8	10.6
85						12.4	11.8	13.4	8.6	11.2	12.4	10.4	10.4	9.6	9.2
90						11.6	10.4	12.0	7.4	10.0	11.2	9.2	9.2	8.4	8.2
95						8.2	9.2	10.6	6.0	9.0	10.0	8.2	8.2	7.4	7.2
100							8.2	9.6	5.0	7.8	9.0	7.2	7.2	6.4	6.2
105							7.2	8.6	4.0	6.8	8.0	6.4	6.4	5.6	5.4
110								7.6	3.2	6.0	7.0	5.6	5.6	4.8	4.6
115								6.8	2.4	5.2	6.2	4.8	5.0	4.2	3.8
120										4.4	5.6	4.0	4.2	3.6	3.2
125										3.8	4.8	3.4	3.6	2.8	2.6
130										3.2	4.2	2.8	3.0	2.2	2.0
135										2.6	3.6	2.2	2.4		
140										2.0	3.2				
145											2.6				

*Boom length noted represents range of similar lengths.

THIS CHART IS ONLY A GUIDE AND SHOULD NOT BE USED TO OPERATE THE CRANE.

The individual crane's load chart, operating instructions and other instructional plates must be read and understood prior to operating the crane

LOAD CHART

Main Boom



37 ft - 197 ft
(11,3 - 60, 0 m)



33,500 lb
(15,2 t)



23.6 ft
(7,2 m)



360°



Pounds x 1000

Feet	37.2	50.5	64.4	77.9	91.3	104.4	117.1	128.4	139.8	150.5	156-162	173.5	184.1	190.4	196.9
10	165.0	166.0	164.0												
15	129.0	129.0	129.0	128.0											
20	103.0	105.0	104.0	103.0	100.0	82.0	69.0								
25	81.0	83.0	82.0	79.0	73.0	71.0	67.0	54.0							
30		65.0	64.0	60.0	59.0	56.0	54.0	51.0	44.0	38.4					
35		50.0	50.0	50.0	47.0	47.0	43.6	41.0	39.6	38.2	30.4				
40		39.6	41.6	41.0	38.4	38.8	36.0	33.8	32.6	32.8	30.4	25.6	21.8	19.0	17.8
45			33.8	34.2	32.2	32.8	32.8	28.4	27.4	27.6	26.6	25.6	21.8	19.0	17.8
50			28.0	30.2	27.2	28.0	28.4	24.0	23.2	25.2	24.4	24.2	21.8	19.0	17.8
55			23.6	25.6	23.2	24.2	24.6	20.6	20.6	22.4	22.4	21.0	19.8	18.8	17.6
60				22.0	21.6	21.0	21.4	19.0	19.0	19.6	19.8	18.4	18.2	17.2	16.8
65				19.0	20.2	18.2	19.0	17.6	17.6	17.2	17.4	16.2	16.0	15.0	14.6
70				12.6	17.8	15.6	16.8	16.4	16.2	15.2	15.4	14.2	14.0	13.2	12.8
75					15.6	13.8	14.6	15.2	15.0	13.4	14.2	12.6	12.4	11.6	11.2
80					11.4	13.0	12.8	14.2	13.8	12.0	13.0	11.0	11.0	10.2	9.8
85						12.4	11.2	12.6	12.2	10.6	11.6	9.8	9.8	9.0	8.6
90						11.6	9.8	11.4	10.8	9.4	10.4	8.6	8.6	7.8	7.6
95						7.6	9.2	10.0	9.6	8.4	9.4	7.6	7.6	6.8	6.6
100							8.6	9.0	8.6	7.2	8.4	6.6	6.6	5.8	5.6
105							8.2	8.0	7.6	6.2	7.4	5.8	5.8	5.0	4.8
110								7.2	6.8	5.4	6.6	5.0	5.0	4.4	4.0
115								6.4	6.0	4.6	5.8	4.4	4.4	3.6	3.4
120									5.2	4.0	5.0	3.6	3.8	3.0	2.8
125									4.6	3.2	4.4	3.0	3.0	2.4	2.2
130										2.6	3.8	2.4	2.4		
135										2.2	3.2		2.0		
140											2.8				
145											2.2				

*Boom length noted represents range of similar lengths.

THIS CHART IS ONLY A GUIDE AND SHOULD NOT BE USED TO OPERATE THE CRANE.

The individual crane's load chart, operating instructions and other instructional plates must be read and understood prior to operating the crane

LOAD CHART

Main Boom



37 ft – 197 ft
(11,3 – 60, 0 m)



30,800 lb
(14,0 t)



23.6 ft
(7,2 m)



360°



Pounds x 1000

Feet	37.2	50.5	64.4	77.9	91.3	104.4	117.1	128.4	139.8	150.5	156-162	173.5	184.1	190.4	196.9
10	165.0	166.0	164.0												
15	128.0	129.0	129.0	128.0											
20	103.0	104.0	103.0	102.0	97.0	82.0	69.0								
25	80.0	82.0	79.0	76.0	73.0	68.0	67.0	54.0							
30		62.0	61.0	57.0	56.0	56.0	52.0	49.0	44.0	38.4					
35		47.0	49.0	48.0	45.0	45.0	41.8	39.4	37.8	37.6	30.4				
40		36.8	39.8	39.2	36.8	37.2	35.4	32.4	31.2	31.2	30.0	25.6	21.8	19.0	17.8
45			32.4	33.8	30.6	31.2	31.6	27.0	26.0	27.0	26.0	25.2	21.8	19.0	17.8
50			26.8	29.0	25.8	26.6	27.0	22.8	22.6	24.6	24.4	23.2	21.8	19.0	17.8
55			22.4	24.4	22.0	23.0	23.4	20.6	20.6	21.4	21.4	20.0	19.4	18.8	17.6
60				21.0	18.4	20.0	20.4	19.0	19.0	18.6	18.8	17.4	17.2	16.2	15.8
65				18.0	15.6	17.2	18.0	17.6	17.6	16.4	16.6	15.2	15.2	14.2	13.8
70				11.8	13.2	14.8	15.8	16.4	16.2	14.4	15.4	13.4	13.2	12.4	12.0
75					12.0	13.8	13.8	15.2	14.6	12.6	13.8	11.8	11.6	10.8	10.4
80					11.4	13.0	12.0	13.6	13.0	11.2	12.2	10.4	10.2	9.4	9.2
85						12.4	10.4	12.0	11.6	9.8	11.0	9.2	9.0	8.2	8.0
90						11.0	9.2	10.6	10.2	8.8	9.8	8.0	8.0	7.2	6.8
95						7.0	8.0	9.4	9.0	7.8	8.8	7.0	7.0	6.2	6.0
100							7.0	8.4	8.0	6.6	7.8	6.2	6.0	5.4	5.0
105							6.0	7.4	7.0	5.8	6.8	5.2	5.2	4.6	4.2
110								6.6	6.2	4.8	6.0	4.6	4.6	3.8	3.6
115								5.8	5.4	4.2	5.2	3.8	3.8	3.2	2.8
120									4.8	3.4	4.6	3.2	3.2	2.6	2.2
125									4.2	2.8	4.0	2.4	2.6	2.0	
130										2.2	3.4	2.0	2.0		
135											2.8				
140											2.4				

*Boom length noted represents range of similar lengths.

THIS CHART IS ONLY A GUIDE AND SHOULD NOT BE USED TO OPERATE THE CRANE.

The individual crane's load chart, operating instructions and other instructional plates must be read and understood prior to operating the crane

LOAD CHART

Main Boom



37 ft - 197 ft
(11,3 - 60, 0 m)



28,200 lb
(12,8 t)



23.6 ft
(7,2 m)



360°



Pounds x 1000

Feet	37.2	50.5	64.4	77.9	91.3	104.4	117.1	128.4	139.8	150.5	156-162	173.5	184.1	190.4	196.9
10	165.0	165.0	164.0												
15	128.0	129.0	129.0	128.0											
20	102.0	103.0	103.0	99.0	93.0	82.0	69.0								
25	79.0	81.0	77.0	73.0	71.0	65.0	64.0	54.0							
30		60.0	59.0	57.0	54.0	54.0	50.0	32.6	44.0	38.4					
35		46.0	48.0	46.0	43.0	43.2	40.0	29.4	36.0	36.0	30.4				
40		36.4	38.0	37.4	35.0	35.6	35.4	26.8	29.6	29.8	28.6	25.6	21.8	19.0	17.8
45			30.8	33.2	29.2	29.8	30.2	24.4	24.8	27.0	26.0	24.6	21.8	19.0	17.8
50			26.8	27.6	25.0	25.4	25.8	22.4	22.6	23.4	23.4	22.0	20.6	19.0	17.8
55			22.4	23.4	23.2	21.8	22.2	20.6	20.6	20.2	20.4	19.0	18.8	17.8	17.2
60				19.8	21.2	18.8	19.4	19.0	19.0	17.6	17.8	16.6	16.2	15.4	15.0
65				17.0	18.4	16.2	17.0	17.6	17.4	15.4	16.4	14.4	14.2	13.4	13.0
70				10.8	16.0	14.6	15.0	16.2	15.4	13.6	14.6	12.6	12.4	11.6	11.2
75					14.0	13.8	13.0	14.4	13.6	11.8	13.0	11.0	11.0	10.0	9.8
80					11.4	13.0	11.2	12.8	12.2	10.4	11.6	9.6	9.6	8.8	8.4
85						11.8	10.4	11.2	10.8	9.2	10.2	8.4	8.4	7.6	7.2
90						10.4	9.8	10.0	9.6	8.0	9.2	7.4	7.4	6.6	6.2
95						6.4	9.2	8.8	8.4	7.0	8.2	6.4	6.4	5.6	5.2
100							8.0	7.8	7.4	6.0	7.2	5.6	5.6	4.8	4.4
105							7.2	6.8	6.4	5.2	6.4	4.8	4.8	4.0	3.8
110								6.0	5.6	4.4	5.4	4.0	4.0	3.2	3.0
115								5.4	5.0	3.6	4.8	3.4	3.4	2.6	2.4
120									4.2	3.0	4.0	2.6	2.8	2.0	
125									3.6	2.4	3.4	2.0	2.2		
130											2.8				
135											2.4				
140											1.8				

*Boom length noted represents range of similar lengths.

THIS CHART IS ONLY A GUIDE AND SHOULD NOT BE USED TO OPERATE THE CRANE.

The individual crane's load chart, operating instructions and other instructional plates must be read and understood prior to operating the crane

LOAD CHART

Main Boom



37 ft – 197 ft
(11,3 – 60, 0 m)



25,500 lb
(11,6 t)



23.6 ft
(7,2 m)



360°



Pounds x 1000

Feet	37.2	50.5	64.4	77.9	91.3	104.4	117.1	128.4	139.8	150.5	156-162	173.5	184.1	190.4	196.9
10	165.0	165.0	164.0												
15	128.0	129.0	128.0	128.0											
20	101.0	103.0	102.0	94.0	90.0	82.0	69.0								
25	77.0	80.0	76.0	70.0	68.0	63.0	61.0	54.0							
30		58.0	56.0	55.0	52.0	51.0	47.0	45.0	42.6	38.4					
35		44.0	46.0	44.0	41.2	41.4	38.6	35.8	34.4	34.4	30.4				
40		35.2	36.4	37.4	33.4	34.0	34.2	29.2	28.2	29.0	27.4	25.6	21.8	19.0	17.8
45			30.8	31.6	27.8	30.2	28.8	24.4	24.8	26.0	26.0	24.4	21.8	19.0	17.8
50			25.4	26.4	25.0	26.4	24.6	22.4	22.6	22.2	22.2	20.8	19.8	19.0	17.8
55			21.2	22.2	23.2	22.8	21.2	20.6	20.6	19.2	19.4	18.0	17.8	16.8	16.2
60				18.8	20.2	19.8	18.4	19.0	18.8	16.6	17.8	15.6	15.4	14.4	14.0
65				17.0	17.4	17.2	16.0	17.4	16.4	14.6	15.6	13.6	13.4	12.4	12.0
70				10.0	15.2	14.8	14.0	15.4	14.6	12.6	13.8	11.8	11.6	10.8	10.4
75					13.2	13.8	12.2	13.6	12.8	11.0	12.2	10.2	10.2	9.4	9.0
80					11.4	12.4	10.6	12.0	11.4	9.8	10.8	9.0	8.8	8.0	7.8
85						11.0	9.0	10.6	10.2	8.4	9.6	7.8	7.6	6.8	6.6
90						9.8	7.8	9.4	9.0	7.4	8.4	6.8	6.6	5.8	5.6
95						5.8	6.8	8.2	7.8	6.4	7.6	5.8	5.8	5.0	4.8
100							5.8	7.2	6.8	5.4	6.6	5.0	5.0	4.2	3.8
105							5.0	6.4	6.0	4.6	5.8	4.2	4.2	3.4	3.2
110								5.6	5.2	3.8	5.0	3.4	3.4	2.8	2.4
115								4.8	4.4	3.2	4.2	2.8	2.8	2.2	1.8
120									3.8	2.4	3.6	2.2	2.4		
125									3.2	1.8	3.0				
130											2.4				
135											2.0				

*Boom length noted represents range of similar lengths.

THIS CHART IS ONLY A GUIDE AND SHOULD NOT BE USED TO OPERATE THE CRANE.

The individual crane's load chart, operating instructions and other instructional plates must be read and understood prior to operating the crane

LOAD CHART

Main Boom



37 ft - 197 ft
(11,3 - 60, 0 m)



22,900 lb
(10,4 t)



23.6 ft
(7,2 m)



360°



Pounds x 1000

Feet	37.2	50.5	64.4	77.9	91.3	104.4	117.1	128.4	134-139.8	150.5	156-162	173.5	184.1	190.4	196.9
10	165.0	165.0	164.0												
15	128.0	128.0	128.0	128.0											
20	100.0	102.0	100.0	94.0	86.0	82.0	69.0								
25	74.0	77.0	69.0	67.0	65.0	63.0	59.0	54.0							
30		56.0	55.0	53.0	49.0	49.0	45.0	42.4	40.6	38.4					
35		42.2	44.0	42.0	39.2	39.4	38.6	34.0	32.6	32.6	30.5				
40		33.4	34.6	36.2	31.8	33.0	32.6	27.6	27.2	29.0	27.4	25.6	21.8	19.0	17.8
45			29.4	30.2	26.2	29.4	27.4	24.4	24.8	24.8	24.6	23.0	21.6	19.0	17.8
50			24.2	25.0	22.0	25.0	23.2	22.4	22.6	21.0	21.2	19.6	19.4	18.4	17.8
55			20.2	21.0	18.4	21.6	20.0	20.6	20.4	18.2	19.2	17.0	16.6	15.8	15.2
60				17.8	15.4	18.8	17.4	18.6	17.8	15.6	16.8	14.6	14.4	13.4	13.0
65				16.4	13.8	16.2	15.0	16.4	15.6	13.6	14.6	12.6	12.4	11.6	11.2
70				9.2	12.8	14.6	13.2	14.4	13.6	11.8	13.0	11.0	10.8	10.0	9.6
75					12.0	13.4	11.4	12.8	12.0	10.2	11.4	9.4	9.4	8.6	8.2
80					11.2	11.8	9.8	11.2	10.8	9.0	10.0	8.2	8.2	7.4	7.0
85						10.4	8.4	9.8	9.4	7.8	8.8	7.0	7.0	6.2	6.0
90						9.0	7.2	8.6	8.2	6.8	7.8	6.0	6.0	5.2	5.0
95						5.2	6.2	7.6	7.2	5.8	6.8	5.2	5.2	4.4	4.0
100							5.2	6.6	6.2	5.0	6.0	4.4	4.4	3.6	3.4
105							4.4	5.8	5.4	4.0	5.2	3.6	3.6	2.8	2.6
110								5.0	4.6	3.4	4.4	3.0	3.0	2.2	2.0
115								4.4	4.0	2.6	3.8	2.4	2.4		
120									3.4	2.0	3.2				
125									2.8		2.6				
130											2.0				

*Boom length noted represents range of similar lengths.

THIS CHART IS ONLY A GUIDE AND SHOULD NOT BE USED TO OPERATE THE CRANE.

The individual crane's load chart, operating instructions and other instructional plates must be read and understood prior to operating the crane

LOAD CHART

Main Boom

 37 ft – 197 ft
(11,3 – 60, 0 m)

 20,200 lb
(9,2 t)

 23.6 ft
(7,2 m)

 360°



Pounds x 1000

Feet	37.2	50.5	64.4	77.9	90.9	104.4	117.1	128.4	134-139.8	150.5	156-162	172.8	184.1	190.4	196.9
10	165.0	165.0	164.0												
15	128.0	128.0	128.0	128.0											
20	99.0	101.0	96.0	91.0	83.0	79.0	69.0								
25	71.0	74.0	69.0	66.0	62.0	61.0	56.0	52.0							
30		53.0	53.0	51.0	47.0	47.0	43.2	40.4	38.6	38.4					
35		40.0	42.0	41.6	37.2	37.6	37.6	32.2	31.0	31.0	29.6				
40		31.8	34.0	34.6	30.0	33.0	31.0	26.8	27.2	27.8	27.4	24.6	21.8	19.0	17.8
45			27.8	28.8	27.2	27.8	26.0	24.4	24.8	23.4	23.4	21.8	20.4	19.0	17.8
50			22.8	23.8	25.0	23.8	22.0	22.4	22.2	20.0	21.0	18.6	18.2	17.2	16.8
55			19.0	19.8	21.2	20.4	18.8	20.2	19.2	17.0	18.2	15.8	15.6	14.6	14.2
60				18.0	18.2	17.8	16.2	17.6	16.8	14.8	15.8	13.6	13.4	12.6	12.2
65				15.4	15.6	15.6	14.2	15.4	14.6	12.6	13.8	11.8	11.6	10.8	10.4
70				8.2	13.4	14.4	12.2	13.6	12.8	11.0	12.0	10.2	10.0	9.2	8.8
75					11.6	12.6	10.6	12.0	11.2	9.6	10.6	8.8	8.6	7.8	7.4
80					10.4	11.0	9.0	10.6	10.0	8.2	9.4	7.4	7.4	6.6	6.4
85						9.6	7.6	9.2	8.8	7.0	8.2	6.4	6.4	5.6	5.2
90						8.4	6.6	8.0	7.6	6.0	7.2	5.4	5.4	4.6	4.4
95							5.4	7.0	6.6	5.2	6.2	4.6	4.6	3.8	3.4
100							4.6	6.0	5.6	4.4	5.4	3.8	3.8	3.0	2.8
105							3.8	5.2	4.8	3.6	4.6	3.0	3.0	2.4	2.0
110								4.6	4.0	2.8	4.0	2.4	2.4		
115								3.8	3.4	2.2	3.2				
120									2.8		2.6				
125									2.4		2.0				

 37 ft – 197 ft
(11,3 – 60, 0 m)

 17,600 lb
(8,0 t)

 23.6 ft
(7,2 m)

 360°



Pounds x 1000

Feet	37.2	50.5	64.4	77.9	90.9	104.4	117.1	128.4	134-139.8	150.5	156-159	172.8	184.1	190.4	196.9
10	164.0	165.0	163.0												
15	128.0	128.0	128.0	127.0											
20	98.0	100.0	92.0	87.0	83.0	75.0	69.0								
25	67.0	70.0	63.0	64.0	59.0	58.0	53.0	50.0							
30		51.0	51.0	48.0	45.0	45.0	42.0	38.2	36.6	36.4					
35		38.8	37.8	40.4	35.2	36.0	35.8	30.4	29.8	31.0	28.2				
40		30.0	32.6	32.8	29.6	31.4	29.4	26.8	27.2	26.4	26.2	24.4	21.8	19.0	17.8
45			26.4	27.2	27.2	26.4	24.6	24.4	24.6	22.2	22.6	21.6	20.0	19.0	17.8
50			21.6	22.4	23.6	22.4	20.8	22.0	21.0	18.8	19.8	18.4	17.2	16.2	15.6
55			17.8	19.6	20.0	19.2	17.8	19.0	18.2	16.0	17.0	15.8	14.6	13.6	13.2
60				17.0	17.0	17.0	15.2	16.6	15.8	13.8	14.8	13.6	12.6	11.6	11.2
65				14.4	14.6	15.6	13.2	14.4	13.6	11.8	12.8	11.8	10.8	9.8	9.6
70				7.6	12.6	13.4	11.4	12.8	12.0	10.2	11.2	10.2	9.2	8.4	8.0
75					10.8	11.8	9.8	11.2	10.4	8.8	9.8	8.8	7.8	7.0	6.8
80					9.6	10.2	8.2	9.8	9.2	7.4	8.6	7.6	6.6	6.0	5.6
85						9.0	7.0	8.4	8.0	6.4	7.4	6.6	5.6	4.8	4.6
90						7.8	5.8	7.4	7.0	5.4	6.6	5.6	4.8	4.0	3.8
95							4.8	6.4	6.0	4.6	5.6	4.8	4.0	3.2	2.8
100							4.0	5.4	5.0	3.8	4.8	4.0	3.2	2.4	2.2
105							3.2	4.6	4.2	3.0	4.2	3.4	2.6		
110								4.0	3.6	2.2	3.4	2.6	2.0		
115								3.4	3.0		2.8	2.0			
120									2.4		2.2				

*Boom length noted represents range of similar lengths.

THIS CHART IS ONLY A GUIDE AND SHOULD NOT BE USED TO OPERATE THE CRANE.

The individual crane's load chart, operating instructions and other instructional plates must be read and understood prior to operating the crane

LOAD CHART

Main Boom

 37 ft - 197 ft
(11,3 - 60, 0 m)

 14,900 lb
(6,8 t)

 23.6 ft
(7,2 m)

 360°



Pounds x 1000

Feet	37.2	50.5	64.4	77.9	90.9	104.4	117.1	128.4	134-139.8	150.5	156-159	172.8	184.1	190.4	196.9
10	164.0	165.0	163.0												
15	128.0	128.0	128.0	127.0											
20	96.0	98.0	89.0	82.0	79.0	71.0	69.0								
25	64.0	68.0	63.0	61.0	56.0	55.0	51.0	47.0							
30		48.0	48.0	47.0	42.4	42.4	42.0	36.2	34.6	32.6					
35		36.8	37.8	38.2	33.4	36.0	33.8	29.4	29.8	30.2	28.2				
40		28.2	31.0	31.0	29.6	29.8	27.8	26.8	27.2	24.8	24.8	23.0	21.4	19.0	17.8
45			24.8	25.8	26.4	25.0	23.2	24.4	23.2	21.8	21.8	20.4	19.0	17.8	17.4
50			20.4	21.2	22.4	21.2	19.6	20.8	19.8	19.8	18.6	17.2	16.0	15.0	14.6
55			16.6	18.8	19.0	18.4	16.6	18.0	17.0	17.0	16.0	14.8	13.6	12.6	12.2
60				15.8	16.0	16.8	15.0	15.6	14.6	14.8	13.8	12.6	11.6	10.6	10.4
65				13.4	13.8	14.6	13.8	13.6	12.8	12.8	12.0	10.8	9.8	9.0	8.6
70				7.6	12.0	12.6	12.4	11.8	11.2	11.2	10.4	9.4	8.4	7.6	7.2
75					10.4	11.0	10.8	10.4	9.6	9.8	9.0	8.0	7.2	6.2	6.0
80					9.0	9.4	9.4	9.0	8.4	8.6	7.8	6.8	6.0	5.2	4.8
85						8.2	8.0	7.8	7.4	7.4	6.8	5.8	5.0	4.2	4.0
90						7.2	7.0	6.8	6.2	6.6	5.8	5.0	4.2	3.4	3.0
95							6.0	5.8	5.4	5.6	5.0	4.2	3.4	2.6	2.2
100							5.2	4.8	4.4	4.8	4.2	3.4	2.6		
105							4.4	4.2	3.8	4.0	3.6	2.8	2.0		
110								3.4	3.0	3.2	2.8	2.2			
115								2.8	2.4	2.6	2.2				
120										2.0					

 37 ft - 197 ft
(11,3 - 60, 0 m)

 12,300 lb
(5,6 t)

 23.6 ft
(7,2 m)

 360°



Pounds x 1000

Feet	37.2	50.5	64.4	77.9	90.9	103.6	117.1	128.4	139.8	150	156-159	169.9	183.4	190.4	196.9
10	164.0	164.0	163.0												
15	127.0	128.0	128.0	124.0											
20	94.0	94.0	86.0	78.0	75.0	70.0	66.0								
25	61.0	65.0	62.0	58.0	53.0	53.0	48.0	45.0							
30		46.0	46.0	46.0	40.2	40.2	40.0	34.0	32.6	32.6					
35		34.8	37.4	36.2	33.0	34.4	32.0	29.4	29.8	28.4	28.2	22.4			
40		26.6	29.2	29.4	29.6	28.2	26.2	26.8	26.0	23.4	24.2	22.2	20.2	19.0	17.8
45			23.4	24.2	24.8	23.6	21.8	23.0	22.0	19.4	20.6	19.0	17.6	16.6	16.2
50			19.2	21.2	21.0	20.0	18.2	19.6	18.6	16.4	17.4	16.2	14.8	14.0	13.4
55			15.6	17.6	17.8	18.2	16.4	16.8	16.0	13.8	15.0	13.8	12.6	11.6	11.2
60				14.8	15.0	15.8	15.0	14.6	13.6	11.8	12.8	11.8	10.6	9.8	9.4
65				12.6	13.2	13.6	13.2	12.6	11.8	10.0	11.0	10.0	9.0	8.2	7.8
70				7.6	11.2	11.8	11.6	11.0	10.2	8.4	9.6	8.6	7.6	6.8	6.4
75					9.6	10.2	10.0	9.6	8.8	7.2	8.2	7.2	6.4	5.6	5.2
80					8.2	8.8	8.6	8.4	7.6	6.0	7.2	6.2	5.2	4.4	4.2
85						7.6	7.4	7.0	6.6	5.0	6.0	5.2	4.4	3.6	3.2
90						6.4	6.4	6.0	5.6	4.2	5.2	4.4	3.4	2.8	2.4
95							5.4	5.2	4.8	3.4	4.4	3.6	2.8	2.0	
100							4.6	4.4	3.8	2.6	3.6	2.8	2.0		
105							3.8	3.6	3.2		3.0	2.2			
110								3.0	2.6		2.4				
115								2.4	2.0						

*Boom length noted represents range of similar lengths.

THIS CHART IS ONLY A GUIDE AND SHOULD NOT BE USED TO OPERATE THE CRANE.

The individual crane's load chart, operating instructions and other instructional plates must be read and understood prior to operating the crane

LOAD CHART

Main Boom

 37 ft – 197 ft
(11,3 – 60, 0 m)

 9,700 lb
(4,4 t)

 23.6 ft
(7,2 m)

 360°



Pounds x 1000

Feet	37.2	50.5	64.4	77.9	90.9	103.6	117.1	122.9	134.3	150	156.3	169.9	183.4	190.4	196.9
10	164.0	164.0	163.0												
15	127.0	128.0	128.0	118.0											
20	92.0	87.0	82.0	76.0	71.0	69.0	62.0								
25	57.0	61.0	59.0	55.0	51.0	50.0	46.0	42.2							
30		43.0	43.2	43.4	37.8	39.6	37.8	32.6	32.6	32.6					
35		32.6	35.2	34.2	33.0	32.6	30.2	29.4	29.8	26.8	26.6	22.4			
40		24.8	27.4	27.6	28.2	26.6	24.6	25.8	24.6	24.0	23.0	21.4	19.8	18.6	17.8
45			22.0	23.0	23.4	22.2	20.4	21.6	20.6	20.4	19.2	17.8	16.4	15.4	15.0
50			17.8	19.8	19.8	20.0	18.0	18.4	17.4	17.4	16.2	15.0	13.8	12.8	12.4
55			14.4	16.4	16.6	17.0	16.4	15.6	14.8	14.8	13.8	12.6	11.6	10.6	10.2
60				13.8	14.4	14.8	14.0	13.6	12.6	12.8	11.8	10.8	9.6	8.8	8.4
65				11.6	12.2	12.8	12.2	11.6	10.8	11.0	10.2	9.2	8.2	7.2	7.0
70				7.0	10.4	10.8	10.6	10.2	9.4	9.4	8.8	7.8	6.8	6.0	5.6
75					8.8	9.4	9.2	8.8	8.0	8.2	7.4	6.4	5.6	4.8	4.4
80					7.4	8.0	7.8	7.6	7.0	7.0	6.4	5.4	4.6	3.8	3.4
85						6.8	6.6	6.4	6.0	6.0	5.4	4.4	3.6	2.8	2.6
90						5.8	5.6	5.4	5.0	5.2	4.6	3.6	2.8	2.0	
95							4.8	4.6	4.0	4.4	3.8	3.0	2.2		
100							4.0	3.8	3.4	3.6	3.0	2.2			
105							3.4	3.0	2.6	2.8	2.4				
110								2.4	2.0	2.2					
115								1.8							

 37 ft – 197 ft
(11,3 – 60, 0 m)

 7,000 lb
(3,2 t)

 23.6 ft
(7,2 m)

 360°



Pounds x 1000

Feet	37.2	50.5	64.4	77.9	90.9	103.6	117.1	122.9	134.3	150	156.3	169.9	183.4	190.4	196.9
10	164.0	164.0	163.0												
15	126.0	127.0	127.0	112.0											
20	87.0	84.0	78.0	74.0	67.0	65.0	59.0								
25	54.0	58.0	56.0	53.0	48.0	47.0	46.0	39.6							
30		41.4	42.4	41.0	36.6	38.6	35.6	32.6	32.6	31.2					
35		30.6	33.2	28.2	32.6	30.8	28.4	29.4	28.0	25.0	24.8	22.4			
40		23.2	25.8	25.4	26.4	25.0	23.0	24.2	23.0	20.4	21.4	19.8	18.4	17.2	16.8
45			20.6	22.6	22.0	21.8	19.8	20.2	19.2	16.8	18.0	16.6	15.2	14.2	13.8
50			16.6	18.6	18.4	18.6	17.8	17.2	16.2	14.0	15.2	13.8	12.6	11.6	11.2
55			13.2	15.4	16.0	16.0	15.2	14.6	13.8	11.6	12.8	11.6	10.6	9.6	9.2
60				12.8	13.4	13.6	13.0	12.4	11.6	9.8	10.8	9.8	8.8	7.8	7.6
65				10.6	11.2	11.8	11.2	10.8	10.0	8.2	9.2	8.2	7.2	6.4	6.0
70				6.0	9.4	10.0	9.8	9.2	8.6	6.8	7.8	6.8	6.0	5.2	4.8
75					8.0	8.6	8.4	8.0	7.2	5.6	6.6	5.8	4.8	4.0	3.8
80					6.6	7.2	7.2	6.8	6.2	4.6	5.6	4.8	3.8	3.0	2.8
85						6.2	6.0	5.8	5.2	3.6	4.8	3.8	3.0	2.2	2.0
90						5.2	5.0	4.8	4.4	2.8	3.8	3.0	2.2		
95							4.2	3.8	3.4	2.0	3.2	2.2			
100							3.4	3.2	2.8		2.6				
105							2.8	2.4	2.0		1.8				
110							2.4	1.8							

*Boom length noted represents range of similar lengths.

THIS CHART IS ONLY A GUIDE AND SHOULD NOT BE USED TO OPERATE THE CRANE.

The individual crane's load chart, operating instructions and other instructional plates must be read and understood prior to operating the crane

LOAD CHART

Main Boom



37 ft - 197 ft
(11,3 - 60, 0 m)



4,400 lb
(2,0 t)



23.6 ft
(7,2 m)



360°



Pounds x 1000

Feet	37.2	50.5	64.4	77.9	90.9	103.6	117.1	122.9	134.3	150	156.3	169.9	183.4	190.4	196.9
10	163.0	164.0	162.0												
15	125.0	126.0	123.0	111.0											
20	82.0	81.0	73.0	70.0	63.0	62.0	55.0								
25	50.0	54.0	52.0	52.0	45.0	44.0	43.8	36.0							
30		38.8	40.0	38.6	36.6	36.2	33.4	32.6	32.6	29.2					
35		28.6	31.0	30.2	30.6	28.8	26.6	27.8	26.2	23.4	24.4	22.4			
40		21.4	24.0	25.4	24.8	23.8	22.0	22.6	21.4	19.0	20.0	18.4	17.0	15.8	15.4
45			19.2	21.2	20.4	20.6	19.6	18.8	17.8	15.6	16.6	15.2	14.0	13.0	12.4
50			15.2	17.2	17.4	17.4	16.6	15.8	15.0	12.8	14.0	12.8	11.6	10.6	10.2
55				14.2	14.8	14.8	14.0	13.4	12.6	10.6	11.8	10.6	9.4	8.6	8.2
60				11.8	12.2	12.6	12.0	11.4	10.6	8.8	10.0	8.8	7.8	7.0	6.6
65				9.6	10.2	10.8	10.4	9.8	9.0	7.2	8.4	7.4	6.4	5.6	5.2
70				5.2	8.6	9.2	8.8	8.4	7.6	6.0	7.0	6.0	5.2	4.4	4.0
75					7.2	7.8	7.6	7.2	6.4	4.8	5.8	5.0	4.0	3.2	3.0
80					6.0	6.4	6.4	6.0	5.4	3.8	4.8	4.0	3.2	2.4	2.0
85						5.4	5.2	5.0	4.6	2.8	4.0	3.2	2.2		
90						4.6	4.4	4.0	3.6	2.2	3.2	2.4			
95						3.8	3.6	3.2	2.8		2.6				
100							2.8	2.6	2.2		2.0				
105							2.2	2.0							
110							2.0								



37 ft - 197 ft
(11,3 - 60, 0 m)



1,700 lb
(0,8 t)



23.6 ft
(7,2 m)



360°



Pounds x 1000

Feet	37.2	50.5	64.4	77.9	90.9	103.6	117.1	122.9	134.3	150	156.3	169.9	183.4	190.4	196.9
10	163.0	164.0	162.0												
15	123.0	124.0	116.0	106.0											
20	77.0	77.0	72.0	66.0	60.0	58.0	52.0								
25	47.0	51.0	49.0	49.0	41.8	44.0	41.2	36.0							
30		36.2	37.6	36.2	36.2	34.0	31.4	32.4	30.6	27.2					
35		26.4	29.0	29.0	28.6	27.0	24.8	26.0	24.6	21.6	22.8	21.0			
40		19.6	22.6	24.0	23.0	23.0	22.0	21.2	20.0	17.4	18.6	17.0	15.6	14.6	14.0
45			17.6	19.6	19.4	19.2	18.2	17.6	16.6	14.2	15.4	14.0	12.8	11.8	11.2
50			14.0	16.0	16.2	16.0	15.4	14.6	13.8	11.6	12.8	11.6	10.4	9.4	9.0
55			10.8	13.0	13.6	13.6	13.0	12.4	11.6	9.6	10.6	9.6	8.4	7.6	7.2
60				10.6	11.2	11.6	11.0	10.4	9.6	7.8	9.0	7.8	6.8	6.0	5.6
65				8.8	9.4	9.8	9.4	8.8	8.2	6.4	7.4	6.4	5.4	4.6	4.4
70				4.2	7.8	8.2	8.0	7.4	6.8	5.0	6.2	5.2	4.4	3.6	3.2
75					6.4	7.0	6.8	6.4	5.6	4.0	5.2	4.2	3.2	2.6	2.2
80					5.2	5.8	5.6	5.4	4.6	3.0	4.2	3.2	2.4		
85						4.8	4.6	4.4	3.8	2.2	3.4	2.4			
90						3.8	3.8	3.4	3.0		2.6				
95							3.0	2.6	2.2		2.0				
100							2.2	2.0							

*Boom length noted represents range of similar lengths.

THIS CHART IS ONLY A GUIDE AND SHOULD NOT BE USED TO OPERATE THE CRANE.

The individual crane's load chart, operating instructions and other instructional plates must be read and understood prior to operating the crane

WORKING RANGE

Main Boom and Bi-fold Swingaway



37 ft - 197 ft
(11,3 - 60,0 m)



0°-40°
30.9 ft - 52.5 ft
(9,4 m - 16 m)



57,700 lb
(26 t)



23.6 ft
(7,2 m)



360°

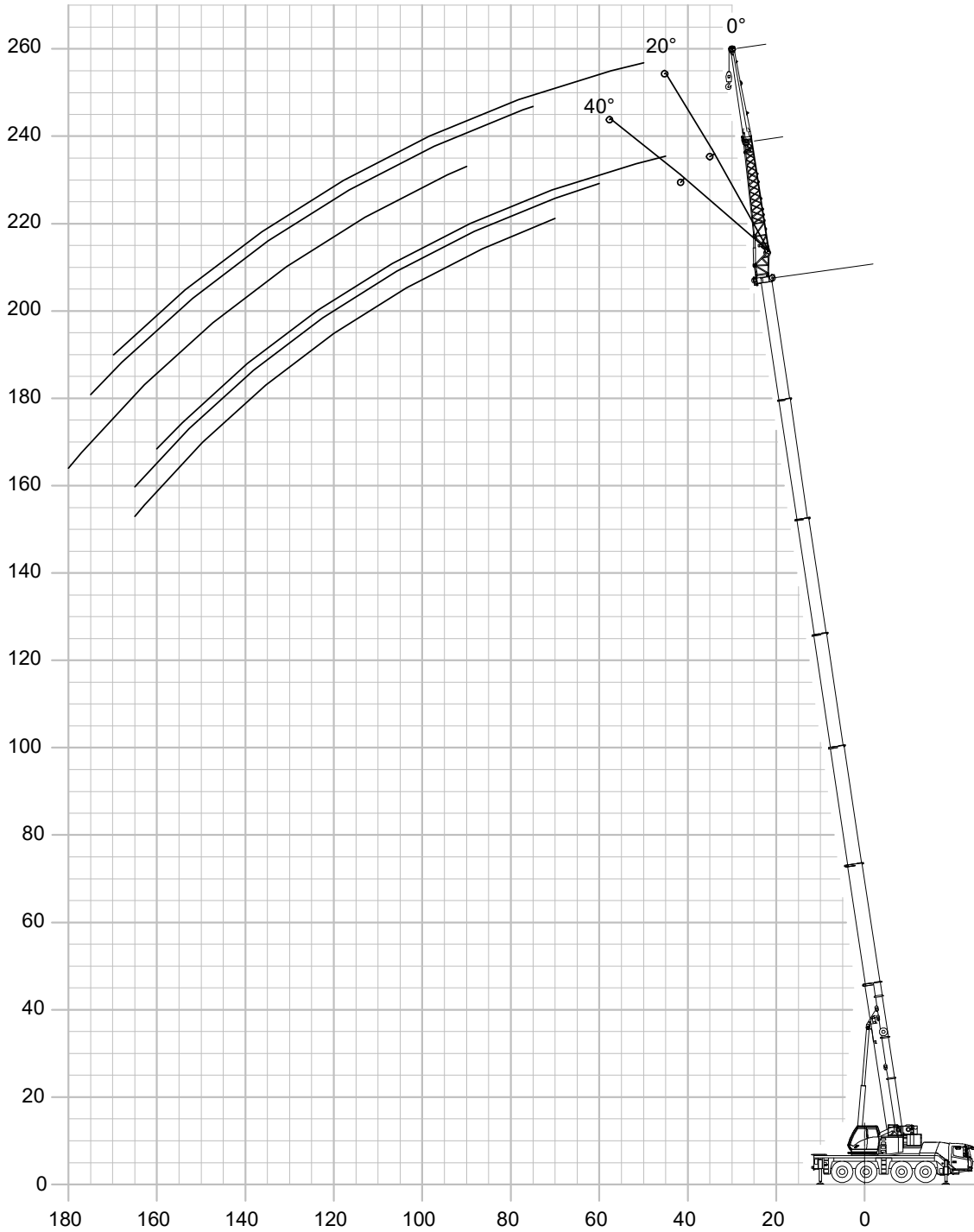

THIS CHART IS ONLY A GUIDE AND SHOULD NOT BE USED TO OPERATE THE CRANE.

The individual crane's load chart, operating instructions and other instructional plates must be read and understood prior to operating the crane

LOAD CHART

Main Boom and Bi-fold Swingaway



37 ft - 197 ft
(11,3 - 60, 0 m)



0°-40°
30.9 ft (9,4 m)



57,700 lb
(26,2 t)



23.6 ft
(7,2 m)



360°



Pounds x 1000

ft	37.2			117.1			184.1			196.9		
	30.9			30.9			30.9			30.9		
	0°	0°-20°	20°-40°	0°	0°-20°	20°-40°	0°	0°-20°	20°-40°	0°	0°-20°	20°-40°
10	31.4											
15	31.4											
20	29.6	16.0										
25	25.2	14.4		28.6								
30	21.6	13.4	12.4	27.8								
35	18.8	12.4	12.0	27.2								
40	16.4	11.6	11.6	26.4	16.0	13.4	12.4					
45	14.6	10.8	11.0	25.8	15.4	13.0	12.4			10.2		
50	13.2	10.0		24.4	14.8	12.8	12.4			10.2		
55	12.0	9.2		23.0	14.2	12.6	12.4	12.4		10.2		
60	11.0			21.6	13.6	12.2	12.4	12.4	11.4	10.2	10.2	
65				20.2	13.2	12.0	12.4	12.4	11.2	10.2	10.2	
70				19.2	12.8	11.8	12.4	12.4	11.2	10.2	10.2	10.2
75				18.0	12.4	11.8	12.4	12.4	11.2	10.2	10.2	10.2
80				17.2	12.0	11.6	12.4	12.4	11.2	10.2	10.2	10.0
85				16.4	11.6	11.4	12.4	12.0	11.0	10.2	10.2	10.0
90				14.8	11.4	11.4	12.2	11.6	11.0	10.0	10.0	10.0
95				13.4	11.2	11.2	11.4	11.2	10.8	9.8	9.8	9.8
100				12.0	10.8	10.8	10.2	10.2	10.4	9.4	9.4	9.4
105				10.6	10.6	10.6	9.2	9.2	9.8	8.8	8.8	9.0
110				9.6	9.6	10.0	8.2	8.2	8.8	8.0	8.0	8.6
115				8.6	8.6		7.4	7.4	8.0	7.2	7.2	7.8
120				7.6	7.6		6.6	6.6	7.2	6.4	6.4	7.0
125				6.8	6.8		6.0	6.0	6.4	5.6	5.6	6.2
130				6.0	6.0		5.2	5.2	5.8	5.0	5.0	5.4
135				5.4			4.6	4.6	5.0	4.4	4.4	4.8
140				1.8			4.0	4.0	4.4	3.8	3.8	4.2
145							3.4	3.4	3.8	3.4	3.4	3.8
150							2.8	2.8	3.2	2.8	2.8	3.2
155							2.4	2.4	2.6	2.2	2.2	2.6
155							1.8	1.8	2.2	1.8	1.8	2.0
160									1.6			1.6

*Boom length noted represents range of similar lengths.

THIS CHART IS ONLY A GUIDE AND SHOULD NOT BE USED TO OPERATE THE CRANE.
The individual crane's load chart, operating instructions and other instructional plates must be read and understood prior to operating the crane

LOAD CHART

Main Boom and Bi-fold Swingaway



37 ft – 197 ft
(11,3 – 60, 0 m)



0°–40°
52.5 ft (16 m)



57,700 lb
(26,0 t)



23.6 ft
(7,2 m)



360°



Pounds x 1000

ft	37.2			117.1			184.1			196.9		
	52.5			52.5			52.5			52.5		
	0°	0°-20°	20°-40°	0°	0°-20°	20°-40°	0°	0°-20°	20°-40°	0°	0°-20°	20°-40°
15	15.6											
20	15.6											
25	15.4											
30	14.2	8.8		14.2								
35	12.6	8.0		13.8								
40	11.6	7.4		13.6								
45	10.6	6.8	6.4	13.4								
50	9.6	6.4	6.0	13.0	8.6		8.2			7.0		
55	9.0	6.0	5.8	12.8	8.2		8.2			7.0		
60	8.2	5.6	5.6	12.6	7.8	6.6	8.2			7.0		
65	7.6	5.0	5.4	12.4	7.6	6.4	8.2			7.0		
70	7.0	4.8	5.0	12.0	7.2	6.2	8.2	8.0		7.0		
75	6.6	4.4		11.4	7.0	6.2	8.2	8.0		7.0	7.0	
80	6.2			10.8	6.6	6.0	8.2	7.8	6.2	7.0	7.0	
85				10.4	6.4	5.8	8.2	7.6	6.2	7.0	7.0	
90				10.0	6.2	5.8	8.2	7.4	6.2	7.0	7.0	5.8
95				9.6	6.0	5.6	8.2	7.2	6.0	7.0	7.0	5.8
100				9.2	5.8	5.6	8.2	7.0	6.0	7.0	7.0	5.6
105				8.8	5.6	5.4	8.2	6.8	6.0	7.0	7.0	5.6
110				8.4	5.6	5.4	8.2	6.6	5.8	7.0	6.8	5.6
115				8.0	5.4	5.4	8.0	6.4	5.8	7.0	6.6	5.6
120				7.8	5.2	5.2	7.2	6.2	5.6	6.8	6.4	5.6
125				7.4	5.2	5.2	6.4	6.2	5.6	6.2	6.2	5.6
130				7.2	5.0	5.0	5.8	5.8	5.6	5.6	5.6	5.6
135				6.6	4.8	5.0	5.2	5.2	5.4	5.0	5.0	5.6
140				5.8	4.6		4.6	4.6	5.4	4.4	4.4	5.2
145				5.2	4.4		4.0	4.0	4.8	3.8	3.8	4.6
150				4.6	4.2		3.6	3.6	4.4	3.4	3.4	4.2
155				4.2			3.0	3.0	3.8	2.8	2.8	3.6
160				3.6			2.6	2.6	3.4	2.4	2.4	3.2
165							2.2	2.2	2.8	2.0	2.0	2.8
170							1.8	1.8	2.4	1.6	1.6	2.2
175									1.8			1.8

*Boom length noted represents range of similar lengths.

THIS CHART IS ONLY A GUIDE AND SHOULD NOT BE USED TO OPERATE THE CRANE.

The individual crane's load chart, operating instructions and other instructional plates must be read and understood prior to operating the crane

WORKING RANGE

Main Boom and Bi-fold Swingaway + Boom Insert



37 ft - 197 ft
(11,3 - 60, 0 m)



0°-40°
78.7 ft (24 m)



57,700 lb
(26,2 t)



23.6 ft
(7,2 m)



360°

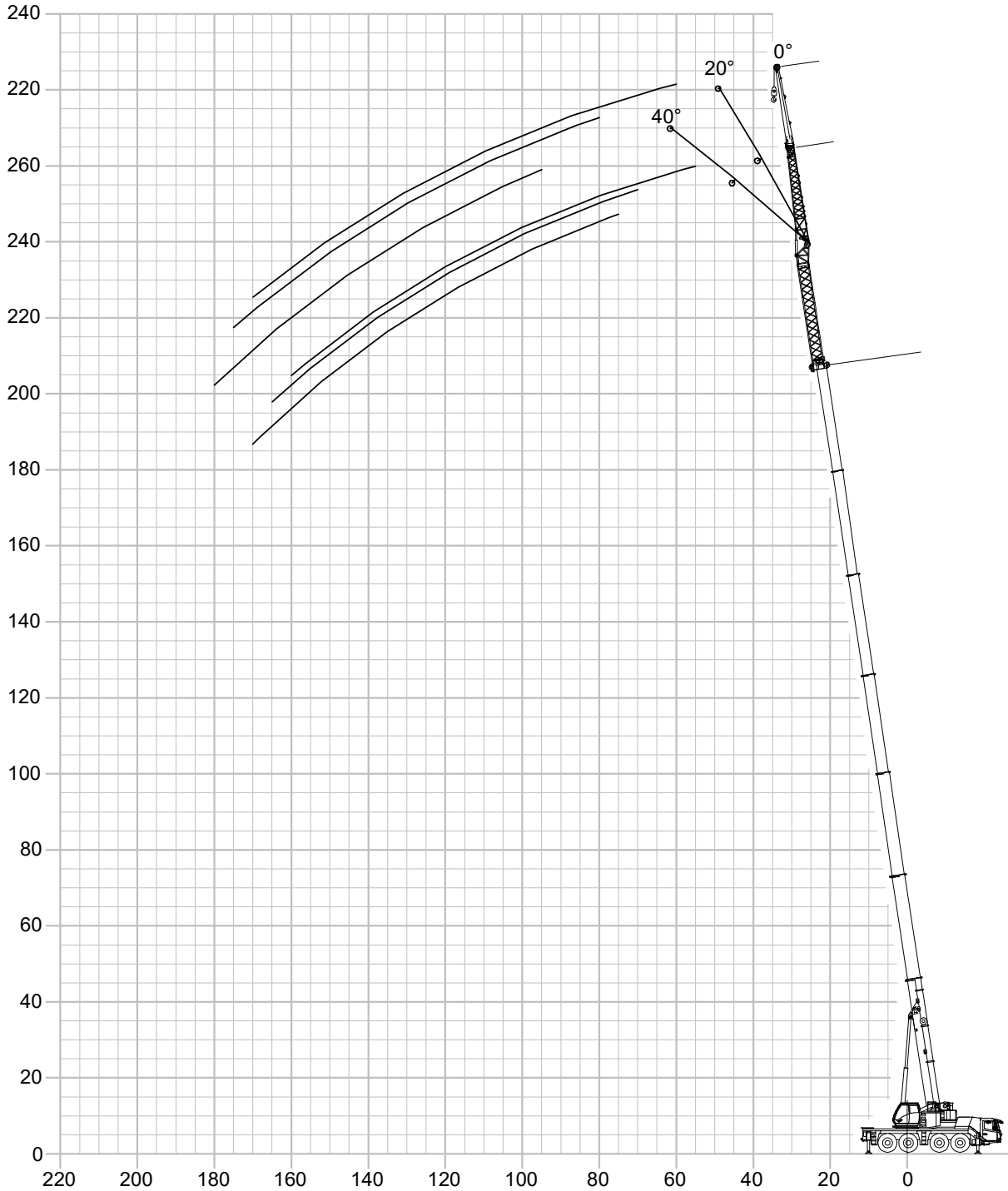

THIS CHART IS ONLY A GUIDE AND SHOULD NOT BE USED TO OPERATE THE CRANE.
The individual crane's load chart, operating instructions and other instructional plates must be read and understood prior to operating the crane

LOAD CHART

Main Boom and Bi-fold Swingaway + Boom Insert



37 ft - 197 ft
(11,3 - 60, 0 m)



0°-40°
78.7 ft (24 m)



57,700 lb
(26,2 t)



23.6 ft
(7,2 m)



360°



Pounds x 1000

ft	37.2			117.1			184.1			196.9		
	78.7			78.7			78.7			78.7		
	0°	0°-20°	20°-40°	0°	0°-20°	20°-40°	0°	0°-20°	20°-40°	0°	0°-20°	20°-40°
20	13.0											
25	12.4											
30	11.6											
35	11.0											
40	10.2	9.0		9.6								
45	9.0	8.0		9.4								
50	8.0	7.4	5.8	9.2								
55	7.4	6.8	5.4	9.0	8.4		5.2					
60	6.6	6.2	5.0	8.8	8.2		5.2			4.2		
65	6.2	5.8	4.6	8.4	7.8		5.2			4.2		
70	5.6	5.4	4.4	8.2	7.4	5.2	5.2			4.2		
75	5.2	5.0	4.0	8.2	7.0	5.0	5.2			4.2		
80	4.8	4.6	3.8	8.0	6.8	5.0	5.2	5.0		4.2	4.2	
85	4.4	4.4	3.6	7.6	6.4	4.8	5.2	5.0		4.2	4.2	
90	4.2	4.0	3.4	7.2	6.2	4.8	5.2	5.0	3.6	4.2	4.2	
95	3.8	3.8	3.2	6.8	5.8	4.6	5.0	5.0	3.6	4.2	4.2	3.2
100	3.6	3.6		6.4	5.6	4.4	5.0	5.0	3.4	4.2	4.2	3.2
105	3.4	3.2		6.2	5.4	4.2	5.0	4.8	3.4	4.2	4.2	3.2
110	3.2			5.8	5.2	4.2	5.0	4.8	3.4	4.2	4.2	3.0
115				5.6	5.0	4.0	5.0	4.8	3.4	4.2	4.2	3.0
120				5.4	4.8	3.8	4.8	4.8	3.4	4.2	4.2	3.0
125				5.2	4.6	3.8	4.8	4.8	3.2	4.2	4.2	3.0
130				5.0	4.4	3.6	4.8	4.6	3.2	4.2	4.2	3.0
135				4.8	4.4	3.4	4.8	4.6	3.2	4.2	4.2	3.0
140				4.6	4.2	3.4	4.4	4.4	3.2	4.0	4.0	3.0
145				4.4	4.0	3.4	3.8	3.8	3.2	3.6	3.6	3.0
150				4.2	4.0	3.2	3.4	3.4	3.2	3.2	3.2	2.8
155				4.0	3.8	3.2	3.0	3.0	3.2	2.6	2.6	2.8
160				3.8	3.6	3.0	2.6	2.6	3.2	2.2	2.2	2.8
165				3.6	3.6		2.2	2.2	2.8	1.8	1.8	2.6
170				3.0	3.0		1.8	1.8	2.4			2.2
175				2.6	2.6				2.0			1.8
180				2.4					1.6			
185				2.0								

*Boom length noted represents range of similar lengths.

THIS CHART IS ONLY A GUIDE AND SHOULD NOT BE USED TO OPERATE THE CRANE.

The individual crane's load chart, operating instructions and other instructional plates must be read and understood prior to operating the crane

SPECIFICATIONS

Superstructure



Boom

37.2 ft to 196.9 ft (11,3 m to 60,0 m) seven section TWIN-LOCK™ boom. Maximum tip height 206 ft (63,0 m).



Boom elevation

1 cylinder with safety valve, boom angle from -1.5° to +82°



Load moment and independent anti-two block system

Load moment and independent anti-two block system with audio visual warning and control lever lock-out. These systems provide graphic display of boom angle, length, radius, tip height, relative load moment, maximum permissible load, load indication and warning of impending two-block condition with lock-out hoist function.



Cab

Aluminium, full vision, tiltable (approx. 20°), safety glass, adjustable operator's seat with suspension (optional), engine-independent heater. Armrest integrated crane controls. Ergonomically arranged instrumentation and crane operating controls.



Slewing

2 slewing gears with axial piston motors, planetary gears.



Counterweight

57,700 lb (26,2 t), consisting of various sections (47,100 lb [21,4 t] within 8.4 ft [2,55 m] vehicle width). Hydraulic removal system.



Hydraulic system

2 separate circuits, 1 axial piston variable displacement pump with electronic power limiting control and 1 axial piston variable displacement pump for slewing. Thermostatically controlled oil cooler. Tank capacity: 145 gallons (550 l).



Control system

Full electronic control of all crane movements using electrical control levers with automatic reset to zero. Integrated with the RCL and engine management system by CAN-BUS. Crane Control System (CCS) with graphic display. Grove CONNECT telematics system.



Hoist

Axial piston motor with planetary gear and brake. Drum rotation indicator. IR - Hoist camera with light.

* Optional equipment

- Bi-fold swingaway 30.9 ft - 52.5 ft (9,4 m -16 m) with hydraulic offset and luffing under load (0° - 40°), controlled from the crane cab
- 26 ft (8 m) boom extension
- Auxiliary hoist (in lieu of compensation counterweight)
- Auxiliary boom nose using two parts of line
- Air-conditioning system
- 6.6 ft (2.0 m) side stowed stub jib using 4 parts of line. Offset 0° and 40°

SPECIFICATIONS

Carrier



Chassis

Special 4-axle chassis, all-welded torsion-resistant box type construction in high strength steel.



Outriggers

4 double hydraulically telescoping beams with vertical cylinders and outrigger pads. Independent horizontal and vertical movement control on each side of the carrier and from the operators cab. Electronic level indicator with automatic levelling system.



Engine

Mercedes Benz OM470LA, diesel, 6 cylinders, water cooled, turbocharged, 430 hp (320 kW) at 1700 rpm (80/1269 EWG fan loose). Max. torque: 1550 ft/lb (2100 Nm at 1300 rpm). Fuel tank: 53 gal + 53 gal (200 l + 200 l). Engine emission: Euromot 5 / EPA / CARB Tier 4 final (non road).



Transmission

Mercedes G 280-16 gears forward and 2 reverse. 2-stage transfer case with longitudinal differential lock.



Drive/Steer

8 x 6 x 8



Axle lines

4 axle lines, axle lines 1, 2, 3 and 4 steered, axle line 1, 3 and 4 driven.



Suspension

MEGATRAK®. All wheels with independent hydropneumatic suspension and hydraulic lockout. Longitudinal and transverse level control with automatic on highway levelling system. Range +7" / -5" (+170 mm/ -126 mm). Active suspension control on outrigger control units.



Tires

8 tires, 14.00 R25 (385/95 R25)



Steering

Dual circuit, hydraulic power assisted steering with emergency steering pump. Axle lines 1, 2 and 4 steer on highway. Separate electronic hydraulic (steer by wire) steering of the 3rd, and 4th axle line for all wheel steering and crabbing.



Brakes

Service brake: pneumatic dual circuit drum brakes acting on all wheels, air dryer.

Permanent brake: exhaust brake and constant throttle brake.

Parking brake: pneumatically operated spring-loaded brake acting on axle lines 2, 3, and 4.



Driver's Cab

Two operator designed, safety glass, driver seat with pneumatic suspension, engine-independent diesel air heater incl. 24 h timer. Complete instrumentation and driving controls. Air conditioning. 12 V plug. Two rotating beacons. Fire extinguisher.



Electrical system

Three-phase alternator 28 V/150A, 2 batteries 12 V/180 Ah. Lighting system and signals 24 V.

* Optional equipment

- 8 x 8 x 8
- 8 tires, size 445/95 R25 (16.00 R25) - Vehicle width 2,75 m (9.0 ft)
- 8 tires, size 525/80 R25 (20.5 R25) - Vehicle width 2,88 m (9.5 ft)
- Secondary water retarder
- Reverse camera system

The Manitowoc Company, Inc.

Regional headquarters

Americas

Milwaukee, Wisconsin, USA
Tel: +1 414 760 4600

Shady Grove, Pennsylvania, USA
Tel: +1 717 597 8121

Europe and Africa

Dardilly, France – TOWERS
Tel: +33 (0) 4 72 18 20 20

Wilhelmshaven, Germany – MOBILE
Tel: +49 (0) 4421 294 0

APAC

Shanghai, China
Tel: +86 21 6457 0066

Singapore
Tel: +65 6264 1188

Middle East and India

Dubai, UAE
Tel: +971 4 8862677

© 2024 The Manitowoc Company, Inc.
Form No. GMK4100L-2 PG
Part No. 22-002/.025M/0724

This document is non-contractual. Constant improvement and engineering progress make it necessary that we reserve the right to make specification, equipment, and price changes without notice. Illustrations shown may include optional equipment and accessories and may not include all standard equipment.



[manitowoc.com](https://www.manitowoc.com)

Courtesy of CraneMarket.com